

OLYMPUS

**OLYMPUS
OM-1**

INSTRUCTIONS



DESCRIPTION OF CONTROLS

Mirror Lock-up Lever •

Rewind Release Lever •

Shoulder
Strap Eyelet

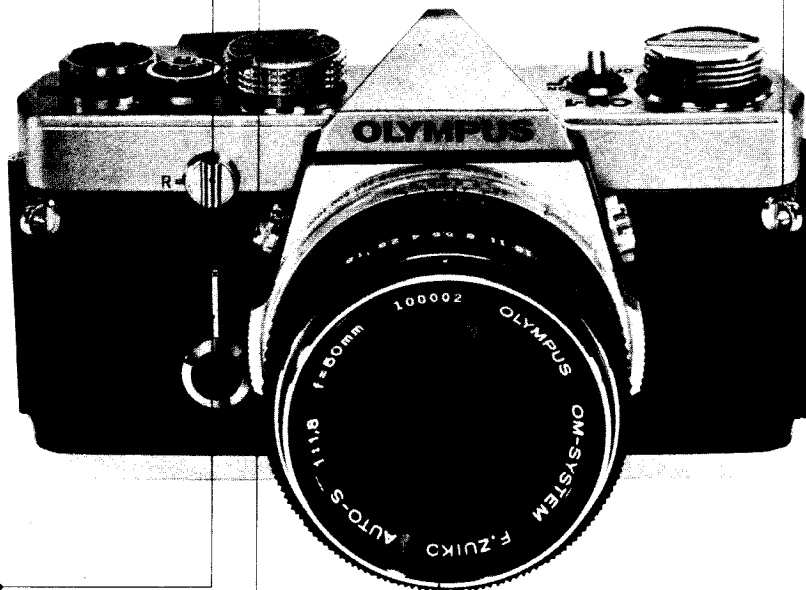

Self-Timer •

Preview Button •

Standard Lens •



DESCRIPTION OF CONTROLS

(The design of the OLYMPUS OM-1 allows the photographer to view every camera control from the top.)

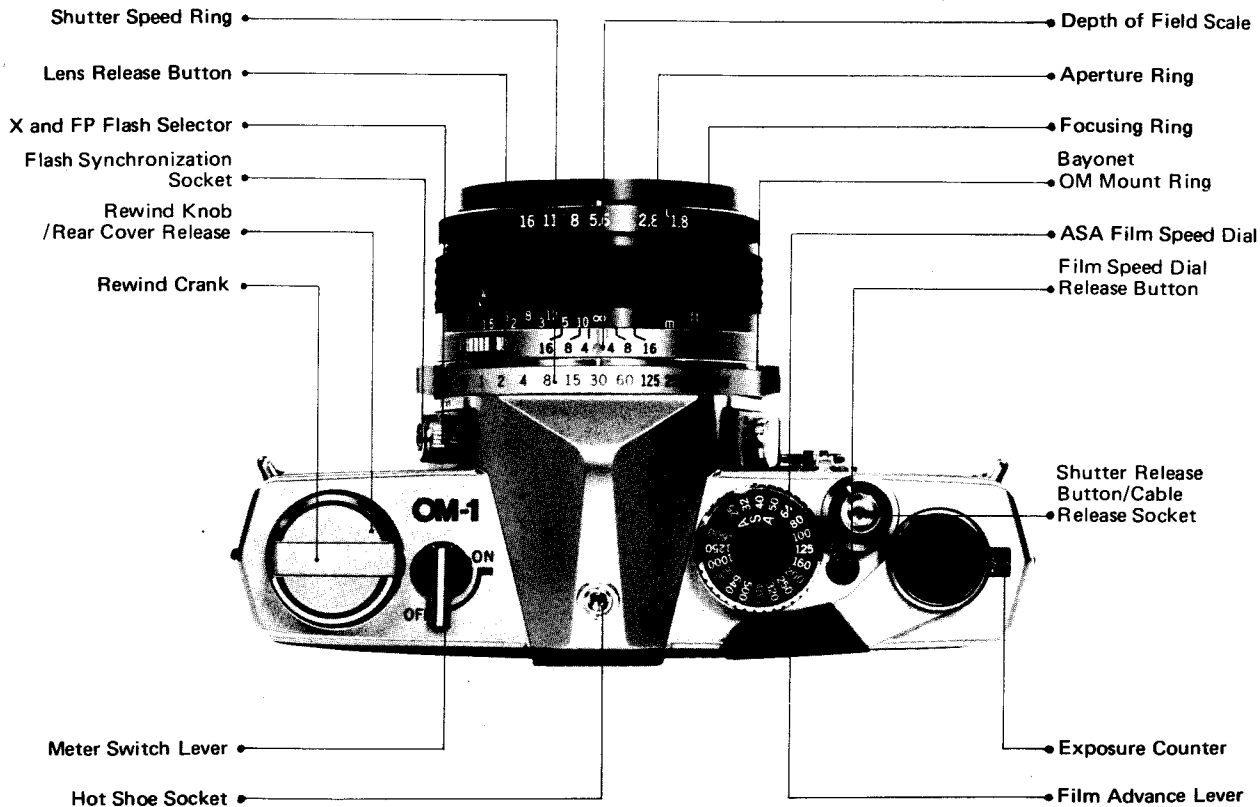

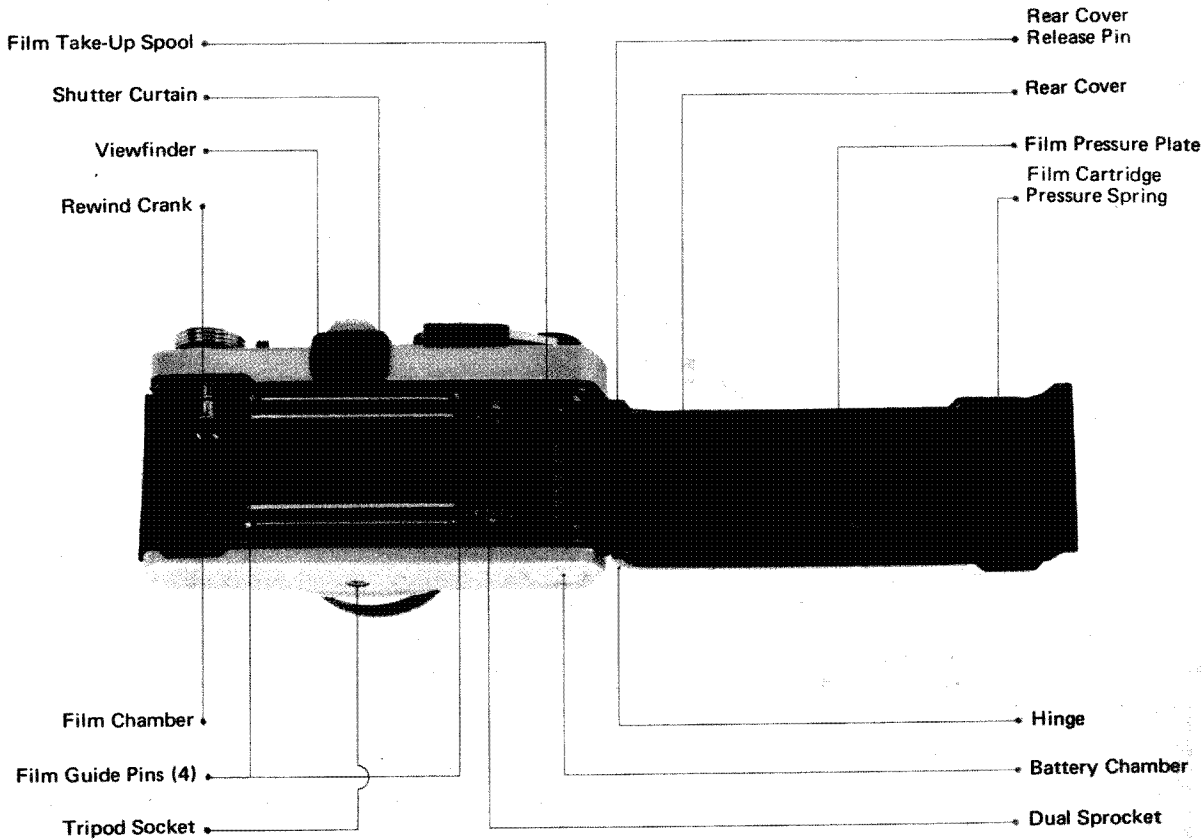



● Description of Controls	1	● Depth of Field Scale	17	● Chart of Motor Drive Group	33
● Specifications	5	● Preview Button	17	● Motor Drive Units	34
● Short Course of Instructions	6	● Depth of Field	18	● Close-Up Photography Group	35
● Inserting the Battery	7	● Holding the Camera	19	● Chart of Close-up Photography Group	37
● Loading the Film	7	● Setting the Self-Timer	20	● Close-Up Photography Units	38
● Operating the Film Advance Lever	9	● Locking up the Mirror	20	● Macrophotography Group	39
● The Exposure Counter	9	● Flash Photography	21	● Chart of Macrophotography Group	40
● Unloading the Film	10	● Flash Units	22	● Macrophotography Units	41
● Making Double Exposures	10	● Some Questions and Answers	23	● Photomicrography Group	45
● Setting the Shutter Speed Ring	11	● The Lens Cap and Lens Hood	24	● Chart of Photomicrography Group	46
● Setting the Aperture Ring	11	● Care and Storage	24	● Photomicrography Units	47
● Setting the ASA Film Speed Dial	12	● Changing the Rear Cover	25	● Chart of Close-up Ranges	50
● The Metering System	12	● Changing the Lens	26	● Other Units	51
● Setting the Exposure	13	● ZUIKO Interchangeable Lens Group	27		
● Focusing	15	● Table of Interchangeable Lenses	29		
● Interchangeable Focusing Screens	16	● Motor Drive Group	31		
● Infrared Photography	17				

System:	OLYMPUS OM-SYSTEM consisting of approximately 280 units.
Camera Type:	35mm Single Lens Reflex with focal plane shutter.
Film Size and Capacity:	35mm perforated film in 12, 20 or 36 exposure cartridges; removable hinged back accepts 250 exposure back and Recordata back (optional accessories).
Film Format:	24mm x 36mm.
Standard Lenses:	50mm F1.8 F Zuiko Auto-S 6 elements in 5 groups. 50mm F1.4 G Zuiko Auto-S 7 elements in 6 groups. 55mm F1.2 G Zuiko Auto-S 7 elements in 6 groups.
Lens Mount:	OLYMPUS OM Mount, bayonet type.
Minimum Focusing Distance:	45cm (17 3/4") with all standard lenses.
Lens Accessory Size:	49mm threaded for F1.8 and F1.4 lenses; 55mm threaded for F1.2 lens.
Shutter:	Focal plane shutter, dial mounted control, with speeds from 1 to 1/1000 second plus B.
Self-Timer:	4-12 second delay lever type; can be stopped after actuation.
Exposure Measurement:	Two highly-sensitive CdS cells located on either side of the eyepiece provide through-the-lens open aperture light measurement. Match needle setting visible in viewfinder. On/Off Switch located atop camera.
Exposure Range:	EV 2-17 (ASA 100 with F1.4 standard lens).
Battery:	1.3 volt mercury battery (Eveready E625, Mallory RM-625R, GE No. 625 or equivalent).
Film Speed Range:	ASA 25-1600.
Viewfinder:	Pentaprism type wide-vision finder shows 97% of actual picture field, Interchangeable focusing screens; Visible exposure meter needle.
Viewfinder Magnification:	0.92X at infinity with standard 50mm lens.
Viewfinder Apparent Field View:	23° 30' & 35°.
Focusing Screens:	1-1 Microprism-matte type provided. Interchangeable with any of 11 additional screens available.
Reflex Mirror:	Oversize, quick return type with mirror lock-up control.
Flash Contacts:	X and FP with switch.
Flash Synchronization:	With electronic flash (X) 1 to 1/60 sec. With Class "M" bulbs (X) 1 to 1/15 sec. With class "F" bulbs (X) 1 to 1/15 sec. With focal plane bulbs (FP) 1/60 to 1/1000 sec.
Hot Shoe Socket:	Built-in. Easy to attach OLYMPUS hot shoe available.
Film Advance:	Ratchet type film advance. May be advanced in one stroke or several short strokes for a total of 150° rotation. Built-in prevention against double advance with double exposure override capability.
Film Loading:	OLYMPUS easy load system.
Exposure Counter:	Progressive type from "S" (Start) to 36 and "E" (End). Counter automatically resets to "S" when rear cover opened.
Film Rewinding:	Rewind crank with automatic resetting rewind release lever.
Rear Cover:	Removable hinge type. Interchangeable with Recordata Back and 250 Film Back.
Dimensions & Weights:	With F1.8 lens: 136mm x 83mm x 81mm (5-3/8" x 3-1/4" x 3-3/16") : 660 gr. (23.3 oz.) With F1.4 lens: 136mm x 83mm x 86mm (5-3/8" x 3-1/4" x 3-3/8") : 720 gr. (25.4 oz.) With F1.2 lens: 136mm x 83mm x 97mm (5-3/8" x 3-1/4" x 3-13/16") : 800 gr. (28.2 oz.) Body only: 136mm x 83mm x 50mm (5-3/8" x 3-1/4" x 2") : 490 gr. (17.3 oz.)

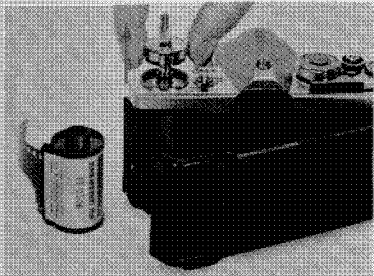

- 1** Load the camera (see page 7). Make sure the battery has been properly inserted and that the rear cover is closed tightly.

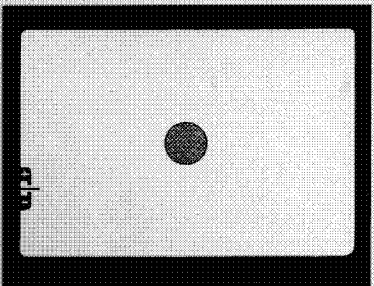

- 4** Look through the viewfinder. Compose and focus. Set the proper exposure (see pages 13, 14, 15).

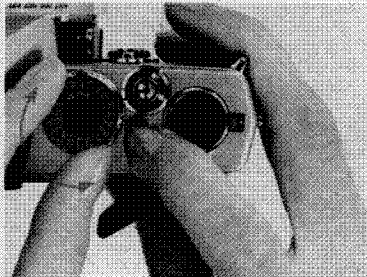

- 2** Set ASA Film Speed (see page 12).

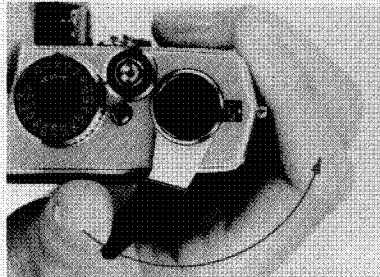

- 3** Advance the film until the figure "1" appears in the exposure counter window (see page 9).

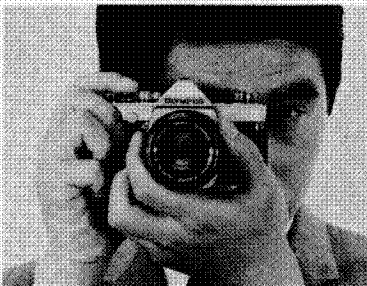

- 5** Take the picture (see page 19). Hold the camera steady and release the shutter with a slow, steady pressure.

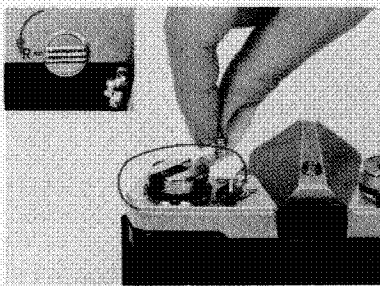

- 6** After the entire film has been exposed, rewind the film back into the cartridge (see page 10).

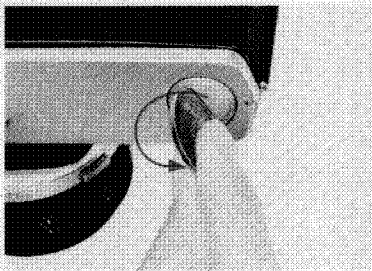

The OLYMPUS OM-1 Camera is supplied with a 1.3V mercury battery especially designed to power its through-lens exposure metering system. It will last approximately one year depending upon use and must be replaced with an Eveready E625, Mallory RM-625R, GE No. 625 or equivalent. Substitutes must not be used. (NOTE: The exposure meter stops functioning when the battery runs out. To prolong battery life, make sure the Meter Switch Lever is in the "OFF" position when the camera is not in use.) To insert the battery:

1) Insert the edge of a coin into the cover of the battery chamber and turn counter-clockwise until the cover has been removed.

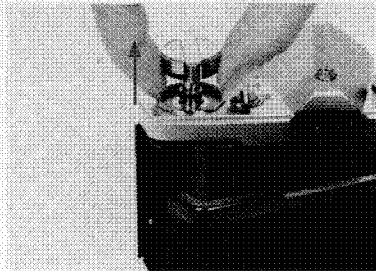

1. Open the rear cover.

Pull up on the rewind knob. A slight resistance may be felt before the rear cover snaps partially open.

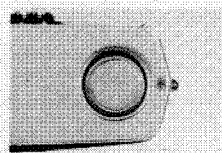

2) Place the battery in the battery chamber making sure the positive side (+) is facing out. The exposure meter does not function if the battery is inserted incorrectly.

3) Replace the cover tightly.

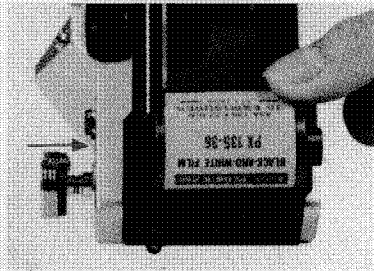

2. Load the camera.

Insert a film cartridge in the film chamber and push the rewind knob back into its original position. It may be necessary to turn the rewind knob slightly before it will lock securely in place.

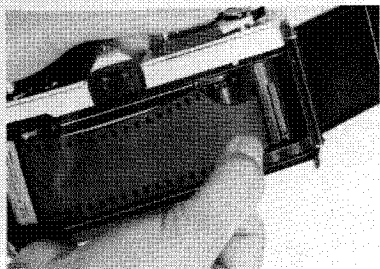

3. Attach the film end to the take-up spool.

Draw out the film leader and insert it into one of the slots in the film take-up spool. Make sure the film is evenly placed between the film guide pins.

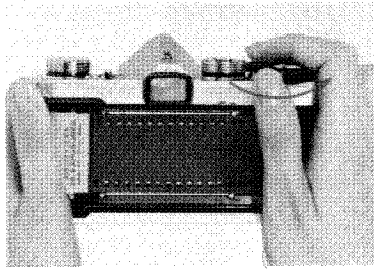

4. Advance the film.

Advance the film using the film advance lever. Make sure that the film perforations engage on the sprockets on both sides.

5. Close the rear cover.

Close the rear cover until it clicks into place.

6. Tighten the film.

After closing the cover, fold out the rewind crank and turn it slowly in a clockwise direction until a slight resistance is felt. This will take up any slack in the film.

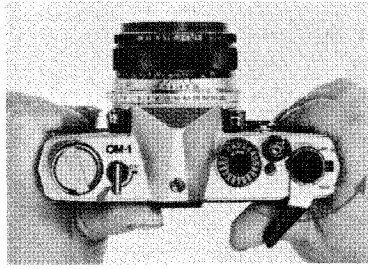

7. Check the exposure counter window.

Advance the film and depress the shutter release button. Advance the film once more until "1" appears in the exposure counter window. The rewind knob will rotate in a counter-clockwise direction indicating that the film is advancing properly.

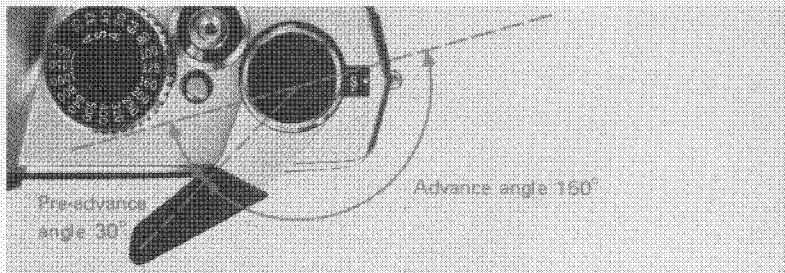

In one stroke the film advance lever:

- 1) advances the film one full frame,
- 2) advances the exposure counter, 3) cocks the shutter, 4) sets the instant return mirror, 5) activates the automatic diaphragm mechanism and 6) activates double advance and double exposure prevention mechanism.

To advance the film:

- 1) Gently pull the film advance lever away from the camera body.
- 2) Advance the lever to the right as far as it will go. **This can be accomplished in a single stroke or in multiple short strokes.**

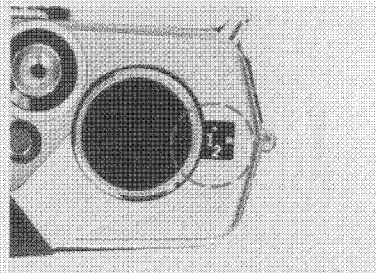

The exposure counter is designed to indicate the total number of frames exposed on the film. Each time the film is advanced by the film advance lever, the exposure counter automatically adds one frame to the total. The counter is indexed in even numbers up to 36 plus "S" (start) and "E" (end). For easy reference, "S", "E", and numbers 12, 20 and 36 are indicated in gold.

Whenever the rear cover is opened, the exposure counter automatically returns to "S".

OLYMPUS OM-1 UNLOADING THE FILM

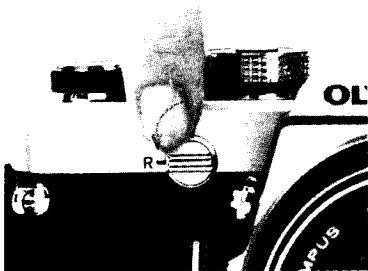

When the entire roll of film has been exposed (indicated by numbers 12, 20 or 36 on the exposure counter depending on film length), rewind the film.

- 1) Turn the rewind release lever counter-clockwise until the red line is opposite the "R".

■ MAKING DOUBLE EXPOSURES

Should you wish to make more than one exposure on the same frame,

- 1) After taking the first exposure, turn the rewind knob slowly in a clockwise direction until it stops to take off any slack in the film.
- 2) Turn the rewind release lever counter-clockwise until the red line is opposite the "R".

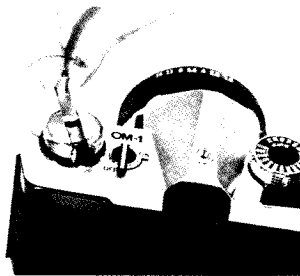

- 2) Fold out the rewind crank and wind it in the direction of the arrow. During the rewind procedure you will feel tension on the crank. When it turns free the film has been completely rewound back into the cartridge.

- 3) Hold both the rewind knob and rewind release lever firmly to prevent them from turning and advance the film advance lever. The shutter will then be cocked for the next exposure of the frame, without the film being advanced.
- 4) Depress the shutter release button with a slow, steady pressure.
- 5) After completing the multiple ex-



- 3) Open the rear cover by pulling up on the rewind crank and remove the film cartridge. Keep camera and film out of direct sunlight.

IMPORTANT: Do not force the film advance lever if the film has been fully exposed. If there is some resistance, rewind the film to prevent tearing.

posure, **cover the lens with a lens cap, advance the film and shoot a blank frame** to avoid overlapping.

You can make as many multiple exposures as you like by repeating the above procedure. With each exposure on the same frame, however, the likelihood of slippage is increased. Practice is required in order to obtain good results.

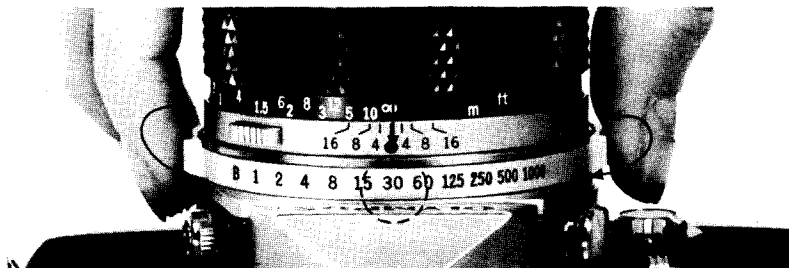

The length of time that light is allowed to strike the film is controlled by the focal plane shutter. The shutter consists of two opaque "curtains" which travel across the opening and allow light to reach the film. The speed and coordinated movement of these curtains determine in fractions of a second the exposure time for your picture. For example, 1000 on the shutter speed ring indicates 1/1000 of a second and 60 indicates 1/60 of a second. The figure 1 indicates one full second. The B (Bulb) setting is used for longer time exposures. At this setting the shutter will remain open as long as the shutter release button is held down. For exposures less than 1/30 of a second, it is advisable to use a cable release, tripod or other steadying devices to avoid

camera movement which can result in blurred or fuzzy pictures. To set the shutter speed turn the shutter speed ring in either direction until the desired number clicks into place opposite the reference dot on the lens barrel. **Set the ring only at click-stop positions as no in-between settings can be used.** Shutter speeds may be set before or after advancing the film.

NOTE: Speeds from "B" to "60" are indicated on the ring in blue as an easy reference to "X" flash synchronization.

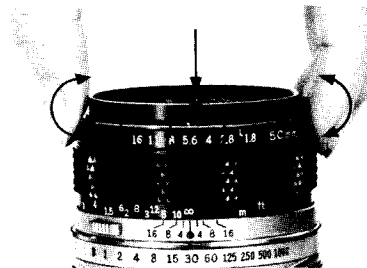

The amount of light allowed to strike the film is represented by "F" numbers or "F" stops engraved on the aperture ring. The higher the F number, the smaller the lens opening (less light); the lower the number, the larger the lens opening (more light). When setting the aperture ring you can use either the click-stop positions or any in-between settings to obtain precise exposure.

All lenses in the OLYMPUS OM-SYSTEM (other than specialized lenses) provide fully automatic diaphragm control allowing you to focus and compose your picture with the lens at maximum aperture or "wide open." The diaphragm will automatically stop down to the preselected F stop at the moment of exposure and immediately re-open when exposure is completed.

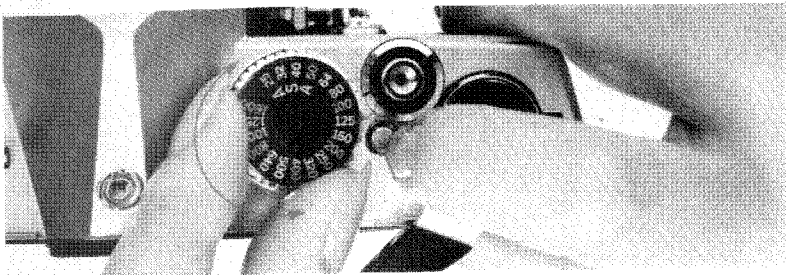

Setting the correct ASA film speed on the camera is one of the most important factors in determining exposure. In order to obtain properly exposed pictures, the correct ASA film speed must be set on the ASA film speed dial. To set the dial:

- 1) Pull the film advance lever slightly away from the camera body.
- 2) Press the film speed dial release button and turn the film speed dial until the ASA rating for the film being used is opposite the black line engraved on the outer ring of the shutter release button.
- 3) Release the button making sure that **the dial is securely in place and does not move.**

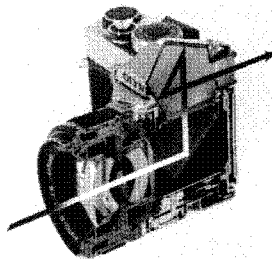
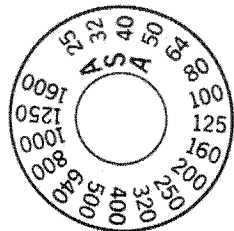

The OLYMPUS OM-1 incorporates a built-in, wide-open exposure metering system which uses two highly-sensitive CdS cells with one positioned on each side of the eyepiece. These cells measure the actual amount of light entering the lens, placing the greatest emphasis at the center of the picture area. Measurements are taken with the lens diaphragm at maximum aperture (wide open) allowing you to take full advantage of a brighter viewfinder when focusing and composing your picture. The OM-1 metering system operates as above with all OM-System camera lenses regardless of the focal length, filters, etc.

OLYMPUS OM-1 SETTING THE EXPOSURE

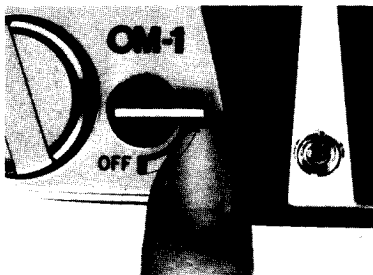

■ Activating the Meter

The OLYMPUS OM-1 metering system is directly coupled to the shutter speed ring, aperture ring and ASA film speed dial.

To activate the meter, move the meter switch lever at the top of the camera to the "ON" position. To prolong battery life, it's a good idea to return the lever to the "OFF" position when the camera is not in use.

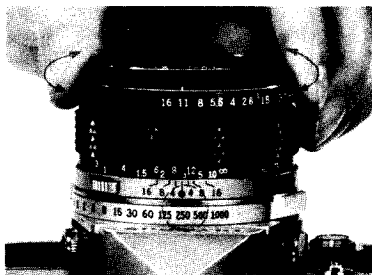

■ Preselecting the Shutter Speed

Should you wish to select a shutter speed to meet a specific photographic situation (for example, to stop fast action, eliminate camera shake, etc.):

- 1) Turn the shutter speed ring until the desired speed is opposite the red reference dot on the camera lens.
- 2) Look through the viewfinder and turn the aperture ring until the needle lines up in the center of the index. For fine exposure adjustment you can use any intermediate F stop position on the aperture ring.
- 3) If the needle will not align properly, select a new shutter speed. To correct over-exposure (+), try a faster speed; to correct under-exposure (-), try a slower speed.

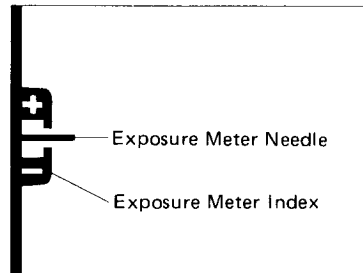

■ Preselecting the F Stop

Should you wish to preselect the F stop (for example, to control depth of field for greater creative impact):

- 1) Turn the aperture ring until the desired F stop is opposite the white index mark at the front of the lens barrel.
- 2) Look through the viewfinder and rotate the shutter speed ring until the needle lines up as close as possible to the center of the index. Make sure that shutter speed meets the other requirements of the situation.
- 3) Make the final exposure adjustment by turning the aperture ring slightly until the needle aligns exactly in the center of the index.

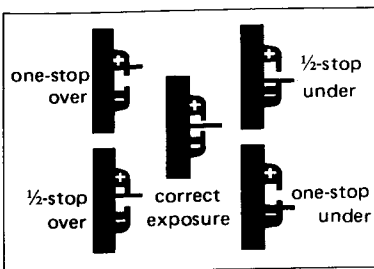

■ Making Intentional Over- or Under-exposures

You can make intentional over- or under-exposures to meet special lighting requirements (such as backlighting, sidelighting, etc.) by using the central index in the viewfinder as a guide. When the needle swings towards the (+) position, it indicates over-exposure. When it swings towards (-), it indicates under-exposure. The exact F stop-needle relationship is shown in the above diagrams.

■ Automatic Low Light Level and Meter "OFF" Warning

When the meter switch lever is "OFF" or when the light is insufficient to produce proper exposures, a warning

switch automatically closes a circuit causing the needle to move entirely out of the viewfinder index. This warning switch does not function if the battery is not inserted properly in the camera.

■ Stop-down Exposure Readings

When using the OM-1 in conjunction with extension tubes, bellows or the Zuiko Shift Lens it is necessary to take meter readings with the lens stopped-down. After setting the desired aperture on the aperture ring, stop the lens diaphragm down and look through the viewfinder. Rotate the shutter speed ring until the needle aligns within the center of the index. (See the instructions on Preselecting the F Stop, page 13.)

■ Special Exposure Techniques

1) Backlighting and Sidelighting

When the most important area of the picture is much darker than the general picture area (strong light hitting the main subject from behind or from the side) the meter will have a tendency to read the brightest part of the picture leaving the main subject under-exposed. To compensate for this, move in towards the subject until most of the

subject image appears in the viewfinder and take your meter reading. After setting the exposure, return to your original position to take the picture. If this procedure cannot be followed, you can obtain approximately the same results by simply opening your lens one full F stop over the indicated meter reading. (NOTE: With backlighting or sidelighting, it's always a good idea to use a lens hood to eliminate unwanted glare.)

2) Strong Frontlighting and Deep Shadows

When taking a picture of a bright subject against a dark background (spotlights, deep shadow areas, etc.) the meter has a tendency to read the darkest part of the picture leaving the main subject over-exposed. To compensate for this use the same procedure for setting exposure as outlined for backlighting. You can also approximate the proper exposure by holding your position and closing the lens down one full F stop from the indicated meter reading.

OLYMPUS
OM-1 FOCUSING



▲ In focus



▲ Out of focus

The OLYMPUS OM-1 comes equipped with a standard microprism-matte type focusing screen which is designed to make focusing quick and easy. To focus, look through the camera viewfinder and turn the focusing ring in either direction until your subject appears sharpest. The "shimmering effect" of the central spot in the focusing screen will disappear when critical focusing has been achieved.

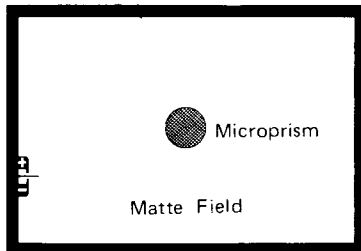

The OM-1 viewfinder takes in 97% of the actual picture area for added convenience when composing your pictures.

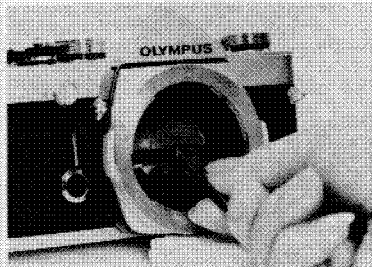
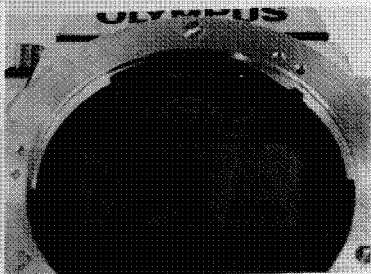

OLYMPUS OM-1 interchangeable focusing screens provide you with the ultimate in focusing versatility. There are optional screens available to suit virtually every picture-taking situation. The optional focusing screens come with a special tool. To remove the focusing screen (for demounting the lens see page 26):

- Insert the tool into the camera and pull on the release catch. This allows the screen and screen frame to drop down.
- Using the tool, the screen can be made to drop completely down without touching it. Remove the screen by gripping the plastic tipped portion of the screen between the tool's jaws and with light but firm pressure remove the screen

from the camera.













- For installing the screen — reverse the above procedure.

IMPORTANT:

Although the above procedure could be done with fingers, the use of a pair of tweezers is a must. Because **changing focusing screens is a procedure to be handled with great care.** Trying to change screens with your fingers can result in fingerprints and costly damage to the surface of the screen, the prism or the mirror. Should this occur, cleaning or repair **MUST** be handled by an authorized service center. Such damage is not covered by the product warranty.

Specifications subject to change without notice.

List of Optional Focusing Screens

1-1  Microprism-matte type (for most lenses)	1-7  Microprism-clear field type (for super telephoto lenses)
1-2  Microprism-matte type (for longer telephoto lenses)	1-8  All microprism type (for wide angle lenses)
1-3  Split image-matte type	1-9  All microprism type (for standard and telephoto lenses)
1-4  All matte type	1-10  Checker-matte type
1-5  Microprism-clear field type (for wide angle lenses)	1-11  Cross Hairs-matte type
1-6  Microprism-clear field type (for standard and telephoto lenses)	1-12  Cross Hairs-clear field type

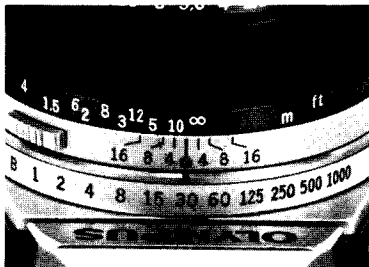

The OLYMPUS OM-1 provides an infrared index mark engraved in red on the depth of field scale to the right of the reference dot. When shooting with infrared film, focus normally on your subject and read the subject distance on the distance scales. Then, turn the focusing ring to the right until the distance reading is opposite the infrared index line. Your lens will then be in focus for average infrared photography. In the above picture the red index is set at infinity.

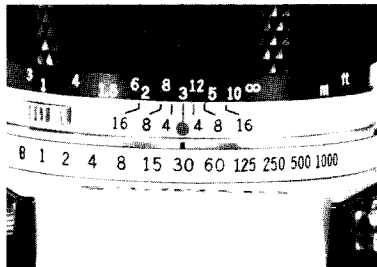

The double series of numbers engraved on the depth of field scale represents F stops: F4, F8 and F16. Once you have focused on your subject, all subjects within the distance range indicated on the lens distance scale between the marks for the F stop you have selected will have acceptable sharpness.

For example, in the above picture the camera-to-subject distance is 3m (10ft) and the lens is set at F16. If you read the distance scale at the points opposite the engraved "16" on both sides of the reference dot, you will find that the depth of field is from 1.9m (6ft) to 7m (23ft). The depth of field can be visually verified by pressing the depth of field preview button.



When you wish to see which objects fall within the acceptable zone of sharpness (depth of field), press the preview button on your lens. The diaphragm of the lens will stop down to the preset F stop enabling you to see the depth of field in the camera viewfinder.

DEPTH OF FIELD

Depth of field is the area of acceptable sharpness in front of and behind the subject in focus. This depth is determined by the F stop you have selected and the distance from the subject in focus to the film plane. As you get closer to your subject or as you open your lens (e.g. from F22 to F2.8) the depth of field becomes shallower. By stopping your lens down (e.g. from F2.8 to F22) or getting farther away from your subject this depth of field or zone of acceptable sharpness can be increased.

Another factor in determining depth of field is the focal length of your lens. As a rule the shorter the focal length, the greater the zone of acceptable sharpness. The longer the focal length, the shallower this zone becomes.

The table above shows that when the camera-to-subject distance is 3m (10ft), the depth of field at F16 ranges from 1.93m (6ft) to 6.93m (23ft).



F1.8 (1/1000 sec.) F16 (1/30 sec.)

Depth of Field Table (F1.8 & F1.4 Standard Lenses) Circle of least confusion 1/30 mm

F Stop	Scale	Camera-to-Subject Distance (m) Figures with * are engraved on the distance scale.									
		+0.45	+0.5	+0.7	+1	+1.5	+2	+3	+5	+10	+∞
1.4		0.45	0.50	0.69	0.99	1.47	1.94	2.86	4.61	8.55	57.78
		~0.45	~0.50	~0.71	~1.02	~1.54	~2.07	~3.16	~5.46	~12.05	~∞
1.8		0.45	0.50	0.69	0.98	1.46	1.92	2.82	4.52	8.21	45.05
		~0.45	~0.50	~0.71	~1.02	~1.55	~2.09	~3.20	~5.60	~12.79	~∞
2		0.45	0.50	0.69	0.98	1.45	1.91	2.80	4.47	8.05	40.57
		~0.45	~0.50	~0.71	~1.02	~1.55	~2.10	~3.23	~5.68	~13.20	~∞
2.8		0.45	0.49	0.69	0.97	1.43	1.88	2.73	4.28	7.47	29.02
		~0.45	~0.51	~0.71	~1.03	~1.57	~2.14	~3.33	~6.01	~15.15	~∞
4		0.44	0.49	0.68	0.96	1.41	1.83	2.63	4.04	6.74	20.35
		~0.46	~0.51	~0.72	~1.04	~1.61	~2.20	~3.49	~6.57	~19.44	~∞
5.6		0.44	0.49	0.67	0.94	1.37	1.77	2.51	3.75	5.96	14.55
		~0.46	~0.51	~0.73	~1.06	~1.66	~2.29	~3.74	~7.52	~31.31	~∞
8		0.44	0.48	0.66	0.92	1.32	1.69	2.34	3.39	5.09	10.21
		~0.46	~0.52	~0.74	~1.09	~1.73	~2.45	~4.18	~9.61	~378.10	~∞
11		0.43	0.48	0.65	0.90	1.27	1.60	2.17	3.02	4.30	7.44
		~0.47	~0.53	~0.76	~1.13	~1.84	~2.68	~4.91	~14.74	~∞	~∞
16		0.43	0.47	0.63	0.86	1.19	1.47	1.93	2.57	3.42	5.13
		~0.48	~0.54	~0.79	~1.20	~2.05	~3.17	~6.93	~138.43	~∞	~∞

F Stop	Scale	Camera-to-Subject Distance (ft) Figures with * are engraved on the distance scale.							
		+2	+3	+4	+6	+8	+12	30	+∞
1.4		1.98	2.96	3.93	5.83	7.69	11.31	25.97	187.12
		~2.02	~3.04	~4.08	~6.18	~8.33	~12.78	~35.51	~∞
1.8		1.98	2.95	3.91	5.78	7.61	11.13	25.02	146.31
		~2.02	~3.05	~4.10	~6.23	~8.43	~13.01	~37.47	~∞
2		1.98	2.94	3.90	5.76	7.57	11.05	24.57	131.88
		~2.02	~3.06	~4.11	~6.26	~8.48	~13.14	~38.54	~∞
2.8		1.97	2.92	3.86	5.67	7.41	10.71	22.91	94.60
		~2.03	~3.08	~4.15	~6.37	~8.69	~13.66	~43.50	~∞
4		1.96	2.89	3.80	5.54	7.19	10.23	20.81	66.45
		~2.05	~3.12	~4.22	~6.54	~9.02	~14.51	~53.91	~∞
5.6		1.94	2.85	3.72	5.38	6.91	9.67	18.54	47.60
		~2.07	~3.17	~4.32	~6.79	~9.51	~15.85	~79.26	~∞
8		1.91	2.79	3.62	5.15	6.53	8.93	15.95	33.41
		~2.10	~3.25	~4.48	~7.20	~10.35	~18.38	~270.28	~∞
11		1.88	2.72	3.49	4.89	6.11	8.15	13.58	23.36
		~2.13	~3.35	~4.69	~7.79	~11.64	~23.00	~∞	~∞
16		1.83	2.61	3.31	4.52	5.53	7.12	10.89	16.80
		~2.20	~3.51	~5.09	~9.02	~14.70	~39.68	~∞	~∞

Proper camera handling is important in assuring the sharpest possible pictures. Even slight camera movement can result in "blurred" photographs. To hold the camera properly, support the camera/lens combination with most of the weight resting in the palm of your left hand, while applying your right hand to the camera's side. Transport the film advance lever with your right thumb and squeeze the release button smoothly using the cushion, not the tip, of your index finger. The aperture ring, focusing ring and shutter speed ring are so arranged as to enable you one hand operation with left fingers right up to the moment the shutter is released. Hold your breath at the moment of shutter release.

※ When holding the camera horizontally, keep both elbows close to the body.

※ For vertical shooting, keep one elbow close to your body and press the camera tightly against your forehead.

※ Steady yourself against any nearby support (such as a tree, fence, or wall) whenever possible.

※ When hand-holding a telephoto lens, camera shake is magnified as the focal length increases. Always try to

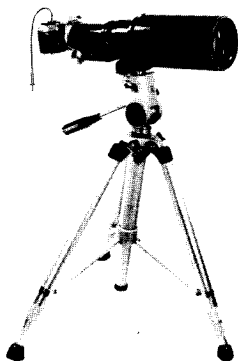
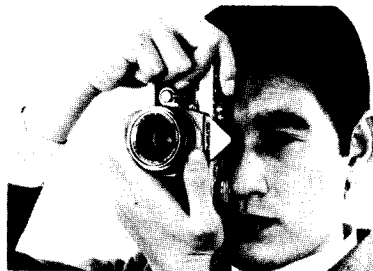

use the fastest possible shutter speed lighting conditions will allow.

※ When shooting under 1/30 of a second, using a stable platform or



tripod with a cable release is recommended. This eliminates the possibility of jarring the camera and is particularly important with telephoto lenses.

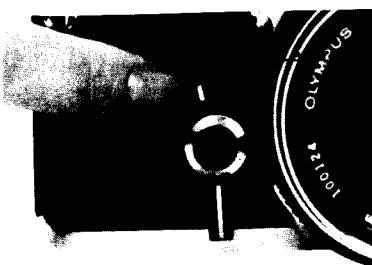

The self-timer provides a method of taking delayed action pictures allowing you to get into your own photographs. It is also ideal for macrophotography when a cable release is not available.

To set the self-timer:

- 1) Rotate the self-timer lever counter-clockwise until it stops (approximately 180°). Make sure the film has been advanced properly.
- 2) Turn the start lever clockwise to the vertical position to activate the self-timer lever. The shutter will then be released in approximately 12 seconds. You can adjust the delay time between four and twelve seconds by adjusting the lever as shown above.

If the film has not been advanced properly, the timer lever will stop halfway and the shutter will not fire. To re-activate the timer, move the start

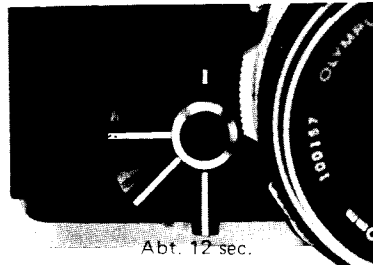

lever counter-clockwise to stop the timer lever, return the timer lever to the starting position, and advance the film. Then, turn the start lever again. NOTE: If you do not reset the self-timer, the timer lever will begin moving immediately after advancing the film and the shutter will be released earlier than expected.

You may set the self-timer lever either before or after advancing the film. Even after setting the lever, you can release the shutter by pressing the shutter release button. To stop the self-timer during its operation, turn the start lever counter-clockwise.

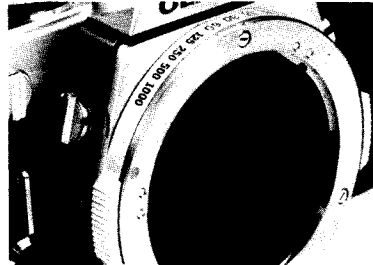

To minimize camera vibration in close-ups, reproduction work, macro-photography and photomicrography, you can lock the instant return mirror in the up position to eliminate mirror shock. This is also handy in rapid sequence shooting. To lock up the mirror, compose and focus on your subject and then turn the mirror lock-up lever counter-clockwise until it stops (approximately 90°). After shooting, always return the lock-up lever to its original position.

NOTE: You can lock up the mirror at any photographing stage — before or after advancing the film. However, do not carry the camera in direct sunlight with the mirror locked up. This can result in damage to the shutter curtains.

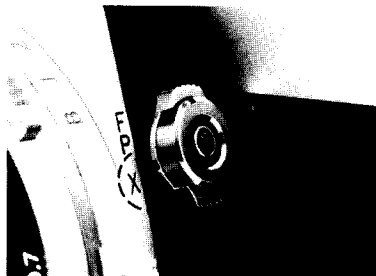

1. First select the proper flash synchronization.

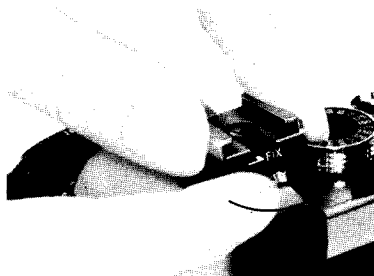

2. Attach the optional accessory shoe. Pull off the black cover on the OM-1 hot shoe socket and mount the accessory shoe to the camera by turning the screw in the direction of the arrow ("FIX").

NOTE: Detach the accessory shoe and replace the black cover whenever a flash is not mounted on the camera or when using "L" bracket to support the flash unit.

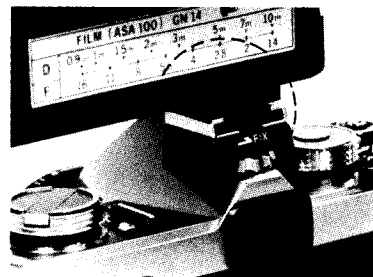

3. Attach the flash unit. Insert the shoe of the flash unit into the accessory shoe and insert the PC tip of the flash into the synchronizing socket. If your flash unit has a built-in hot shoe, simply mount the unit directly to the accessory shoe. Your flash will then be fully synchronized to the camera through the contacts in the shoe.

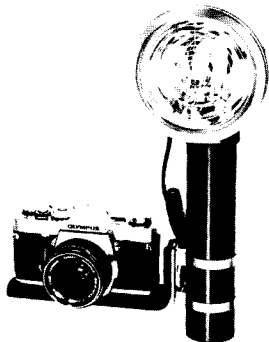

The table indicates proper synchronization speeds for most flash equipment.

Terminal	Flash Bulb	Shutter Speed										
		1000	500	250	125	60	30	15	8	4	2	1
FP	FP	○	○	○	○	○	*	*	*	*	*	*
X	Electronic Flash					○		○		○	○	○
	M F						*			○	○	○
	M · FP									○	○	○

(○ recommended; * not recommended due to bulb quality)



4. Determine the exposure.

First determine the shutter speed that matches the type of flash you are using.

Once you have set the proper shutter speed, determine the F stop by using the calculator dial or exposure table attached to your flash unit. You can determine the F stop manually by using the following formula:

$$F \text{ stop} = \frac{\text{flash guide number}}{\text{flash-to-subject distance}}$$

Additional flash information can be found in the instructions which accompany your flash equipment or flashbulbs.

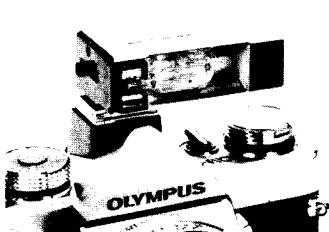

■ **OLYMPUS Flash CL**

This cordless contact microflash is extremely compact and uses standard AG-1, AG-3N and AG-1B type bulbs. Guide number (ASA 80)

- AG-1, AG-3N: 28 (90 in case of feet)
- AG-1B: 20 (65 in case of feet)

■ **Accessory Shoe 1**

When mounted on the OM-1, works as a direct contact shoe.

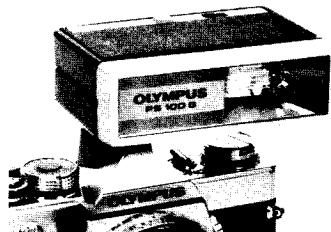

■ **OLYMPUS PS 100G**

OLYMPUS PS 100G Electronic Flash (center contact) operates on 2 pcs. 1.5V penlight batteries and AC house current.

Guide number: 14 (45 in feet) at ASA 80. Color temperature: 6,000° Kelvin. 200 flashes from a set of fresh batteries. 86 x 59 x 29 mm, 120 gr. (3 3/8 x 2 3/8 x 1/8 in., 4 oz.).

In reference to the below exposure table, for example, when the distance scale reads 5m, set the aperture ring at F2.8 (ASA 80).

GN	GN										
		ft		m							
ft	m	ASA	m	3	5	7	10	15	20	30	
90	28	320-500	28	19	14	9.4	5.6	4	2.8		
65	20	160-250	19	14	9.4	7	4	2.8	2		
45	14	80-125	14	9.4	7	4.7	2.8	2	1.4		

Q: My camera is loaded with film but the rewind knob doesn't rotate when I advance the film advance lever. Why?

A: The film leader may not be inserted in the film take-up spool and the film is not advancing properly. See pages 7 & 8.

Q: The film is not advancing. Why?

A: The shutter may be cocked and ready to fire. Release the shutter release button. If this is not the case, your film may be fully exposed. Check the exposure counter. If you feel tension on the film advance lever, DO NOT FORCE IT. Rewind the film. See pages 9 & 10.

Q: The shutter release button will not move and I can't take the picture. Why?

A: The film advance lever may not have been fully advanced. See page 9.

Q: The rewind crank will not turn when I try to rewind the film. Why?

A: The rewind release lever may not be set properly. Make sure the lever is rotated until the red line is opposite the "R." See page 10.

Q: Why can't I turn the ASA film speed dial?

A: The film speed dial release button must be pressed before the dial can be turned. Once the dial had been set, release the button and make sure the dial has locked into place. See page 12.

Q: Why isn't the needle in the viewfinder moving?

A: First, make sure the meter switch lever is set to the "ON" position. If the meter is on, turn the camera towards a bright light source. If the needle still will not move, the battery may not be inserted, may be inserted improperly or may be drained. Replace the battery or insert it properly. See page 7.

Q: The meter needle moves entirely out of the viewfinder index. Why?

A: The meter switch lever may be at the "OFF" position or the subject may not be in light sufficient to make an exposure. This indicates the warning mechanism is working properly. Re-select the shutter speed and F stop combination. See pages 13 & 14.

Q: How do I take meter readings when a bellows or extension tubes are mounted to my camera?

A: Since lens extension devices dis-

connect the automatic diaphragm mechanism between camera and lens, readings must be taken with the lens stopped-down. Take an exposure reading using the procedure outlined on page 14.

Q: The microprism in the center of the viewfinder "shimmers" and gets dark. Is that normal?

A: Yes, this is a natural phenomenon that occurs when a lens with a maximum aperture smaller than F5 is mounted on the camera. It also happens with a standard lens when the depth of field preview button is pressed. The microprism is not faulty.

Q: The viewfinder is totally dark and I can't see anything. Why?

A: Make sure you have removed the lens cap. If the cap has been removed, the mirror lock-up lever may be in the up position. Return the mirror to its operational position. See page 20.

Q: When I touch the terminal socket of the accessory hot shoe I feel current. Why?

A: This is normal when the hot shoe is attached. If you are not using flash or are using a flash bracket, the shoe is not necessary and should be removed. See page 21.

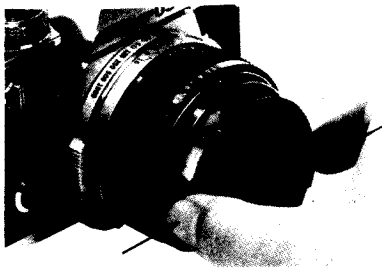

To attach or remove the front lens cap, press the spring-loaded lens cap retaining clips on either side of the cap. The cap then fits easily over the accessory thread of the lens.

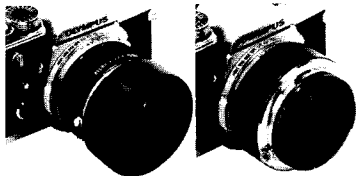

■ Lens hoods protect against extraneous light striking the lens and causing unwanted glare. Hoods for standard lenses are cover types and can be reversed to provide easy storage even when the camera is in the case.

- When you will not use the camera for a long period of time, store it with the shutter uncocked and turn off the self-timer and exposure meter. Keep it free from dust and moisture, and remove it from the case.

- Do not drop the camera and avoid hitting it.

- When storing the camera for a long period of time, remove the battery. Wipe the battery surface with a dry cotton cloth before re-inserting it in the camera.

- Never store the camera where temperatures exceed 50°C (122°F). When you use the camera in temperatures under -20°C (-4°F), it may sometimes fail to operate properly. To avoid this, warm the camera before use. Protect against excess moisture by using silica gel or other desiccant.

- Never expose the camera to direct sunlight. Avoid areas exposed to salt water, salt air, radios, TV sets or magnets.

- Avoid touching the surface of the lens. Clean only with an air brush, anti-static brush, or wipe it lightly with a camel hair brush or lens tissue. In

EXTREME cases use a clean, soft cotton cloth moistened with denatured alcohol. NEVER rub the lens surface with your finger, clothing or any other abrasive material.

- If dust or fingerprints collect on the mirror, focusing screen or prism, take it to an authorized Olympus service center. It needs professional attention.

CHANGING THE REAR COVER

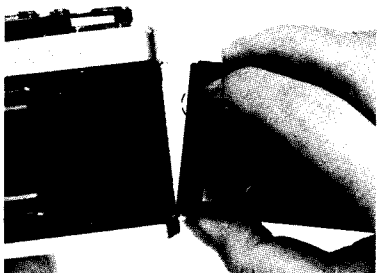

The rear cover of the OM-1 is fully interchangeable with the Recordata Back and 250 Film Back 1. To remove the rear cover, push down on the release pin as shown. Do not remove the cover unless necessary.

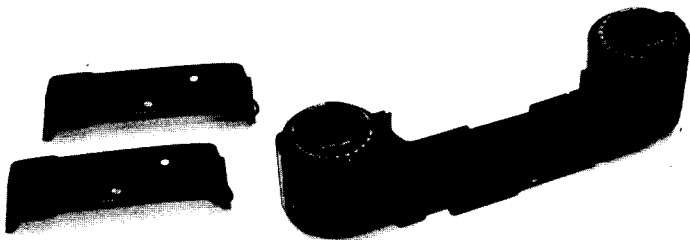

■ **Recordata Backs** — Register data such as date, number, alphabet code, etc. directly on the picture.

■ **250 Film Back 1** — Designed for motor drive shooting, the magazine accepts bulk film for 250 exposures.

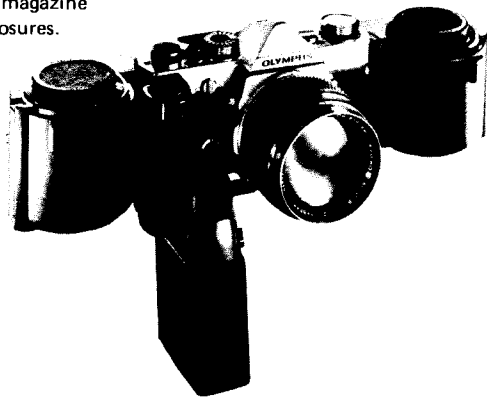

Lens Release Button

Meter Coupling

Lens Mount Ring

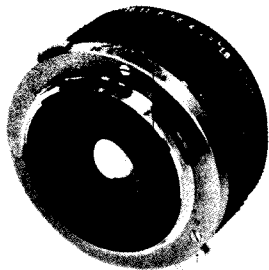

Depth of Field
Preview Button

Automatic Diaphragm Lever

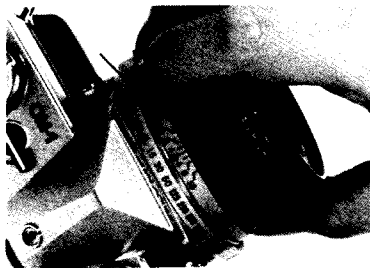

The bayonet mount of the OLYMPUS OM-1 allows you to change lenses quickly and easily.

To detach the lens, press down on the lens release button and turn the lens counter-clockwise. Grasp the lens firmly and remove it from the camera body.

Protect your lens and camera! Always attach the front and rear lens caps when the lens is removed from the camera to prevent any possibility of damage. Never leave the camera body in direct sunlight with the lens removed and, if you plan to store the camera without the lens, the use of a body cap is recommended.



To mount the lens, grasp the lens firmly and align the red dots on the lens flange and the camera mount ring. Turn the lens clockwise until it locks in place. The lens release button will spring up and you will hear a positive "click" when the lens has been fully engaged. **Do not apply pressure to the lens release button during the mounting procedure.** This will assure proper coupling between the lens and the meter.

One of many advantages of the single lens reflex type of camera is the large variety of interchangeable lenses available. The Zuiko Interchangeable Lens Group (designed and manufactured by Olympus) comprises 38 lenses including those now in the course of development. Zuiko lenses have always enjoyed a high reputation in photographic circles — new design technology has made possible a new series of innovative, high performance lenses. These lenses have a host of special features including a new construction that compensates for close focus aberrations, increased aperture ratio in the wide angle lenses, and reduction in telephoto lens size and weight. The OM-System adopts 49mm filters for most lenses from 21mm to 200mm. As part of the OM-System design all the lenses now offer higher performance in small configurations. Olympus has produced lenses for microscopes for many years and the new Zuiko lenses benefit from this scientific experience. See the "OM-System Zuiko Interchangeable Lenses" instructions for further information.

TYPE	INTERCHANGEABLE LENSES*		ANGLE OF VIEW	OPTICAL CONSTRUCTION ELEMENT-GROUP
FISHEYE	ZUIKO AUTO-FISHEYE	8mm F2.8	180°	11-7
	ZUIKO AUTO-FISHEYE	16mm F3.5	180°	11-8
SUPER WIDE	L ZUIKO AUTO-W	18mm F3.5	100°	12-10
	G ZUIKO AUTO-W	21mm F3.5	92°	7-7
	J ZUIKO AUTO-W	24mm F2	83°	10-8
	I ZUIKO AUTO-W	24mm F2.8	83°	9-7
WIDE	I ZUIKO AUTO-W	28mm F2	75°	9-8
	G ZUIKO AUTO-W	28mm F3.5	75°	7-7
	H ZUIKO AUTO-W	35mm F2	63°	8-7
	G ZUIKO AUTO-W	35mm F2.8	63°	7-6
STANDARD	G ZUIKO AUTO-S	55mm F1.2	43°	7-6
	G ZUIKO AUTO-S	50mm F1.4	47°	7-6
	F ZUIKO AUTO-S	50mm F1.8	47°	6-5
ZOOM	ZUIKO-AUTO-ZOOM	75-150mm F4	32°-16°	15-11
TELEPHOTO	F ZUIKO AUTO-T	85mm F2	29°	6-4
	E ZUIKO AUTO-T	100mm F2.8	24°	5-5
	E ZUIKO AUTO-T	135mm F2.8	18°	5-5
	E ZUIKO AUTO-T	135mm F3.5	18°	5-4
	E ZUIKO AUTO-T	200mm F4	12°	5-4
	F ZUIKO AUTO-T	200mm F5	12°	6-5
SUPER TELEPHOTO	F ZUIKO AUTO-T	300mm F4.5	8°	6-4
	F ZUIKO AUTO-T	300mm F6.3	8°	6-5
	F ZUIKO AUTO-T	400mm F4.5	6°	6-4
	E ZUIKO AUTO-T	400mm F6.3	6°	5-5
	F ZUIKO AUTO-T	600mm F6.5	4°	6-4
	E ZUIKO AUTO-T	1000mm F11	2.5°	5-5
SPECIAL USE	ZUIKO SHIFT	35mm F2.8	63°-84°	8-7
	ZUIKO AUTO-MACRO	50mm F3.5	47°	5-4
	ZUIKO MACRO	20mm F3.5	9° at highest mag.	4-3
	ZUIKO MACRO	38mm F3.5	9° at highest mag.	5-4
	ZUIKO 1 : 1 MACRO	80mm F4	9° at highest mag.	6-4

DIA. PHRAGM	F-STOP RANGE	MIN. FOCUS (feet)	MIN. PHOTO-GRAPHIC RANGE	WEIGHT (oz)	MAX			FILTER					
					DIAMETER			49mm	55mm	72mm	100mm		
AUTO.	2.8-22	0.2 m (0.7)		690g (24.3)	72mm	102mm		—	Built-in (L39, Y44, P55, R60)				
AUTO.	3.5-22	0.2 m (0.7)		170g (6.0)	28mm	59mm		—	Built-in (L39, Y44, P55)				
AUTO.	3.5-16	0.2 m (0.7)	21×14cm	250g (8.8)	42mm	75mm	72mm	Screw-in					
AUTO.	3.5-16	0.2 m (0.7)	21×14cm	170g (6.0)	31mm	59mm	49mm	Screw-in	○				
AUTO.	2-16	0.25m (0.8)	23×15cm	250g (8.8)	49mm	60mm	55mm	Screw-in		○			
AUTO.	2.8-16	0.25m (0.8)	23×15cm	190g (6.7)	36mm	60mm	49mm	Screw-in	○				
AUTO.	2-16	0.3 m (1.0)	27×18cm	230g (8.1)	43mm	60mm	49mm	Screw-in	○				
AUTO.	3.5-16	0.3 m (1.0)	27×18cm	160g (5.6)	31mm	59mm	49mm	Screw-in	○				
AUTO.	2-16	0.3 m (1.0)	21×14cm	230g (8.1)	42mm	60mm	55mm	Screw-in		○			
AUTO.	2.8-16	0.3 m (1.0)	21×14cm	170g (6.0)	33mm	59mm	51mm	Slide-on	○				
AUTO.	1.2-16	0.45m (1.5)	23×15cm	310g (10.9)	47mm	65mm	57mm	Slide-on		○			
AUTO.	1.4-16	0.45m (1.5)	24×16cm	230g (8.1)	36mm	60mm	51mm	Slide-on	○				
AUTO.	1.8-16	0.45m (1.5)	24×16cm	170g (6.0)	31mm	59mm	51mm	Slide-on	○				
AUTO.	4-22	1.6 m (5.2)	36×24cm 74×49cm	400g (14.1)	115mm	63mm		Built-in	○				
AUTO.	2-16	0.85m (2.8)	29×19cm	230g (8.1)	47mm	60mm	49mm	Screw-in	○				
AUTO.	2.8-22	1 m (3.3)	29×19cm	230g (8.1)	48mm	60mm	49mm	Screw-in	○				
AUTO.	2.8-22	1.5 m (4.9)	32×21cm	350g (12.3)	80mm	61mm		Built-in		○			
AUTO.	3.5-22	1.5 m (4.9)	32×21cm	280g (9.9)	73mm	60mm		Built-in	○				
AUTO.	4-32	2.5 m (8.2)	36×24cm	490g (17.3)	127mm	67mm		Built-in		○			
AUTO.	5-32	2.5 m (8.2)	36×24cm	360g (12.7)	105mm	63mm		Built-in	○				
AUTO.	4.5-32	3.5 m (11.5)	33×22cm	1000g (35.3)	181mm	80mm		Built-in			○		
AUTO.	6.3-32	3.5 m (11.5)	33×22cm	600g (21.2)	171mm	70mm		Built-in		○			
AUTO.	4.5-32	5 m (16.4)	35×23cm	2200g (77.6)	257mm	110mm		Built-in				○	
AUTO.	6.3-32	5 m (16.4)	35×23cm	1400g (49.4)	255mm	80mm		Built-in			○		
AUTO.	6.5-32	11 m (36.1)	54×36cm	2800g (98.8)	377mm	110mm		Built-in				○	
AUTO.	11-45	30 m (98.4)	98×65cm	4800g (169.3)	662mm	110mm		Built-in					○
MANUAL	2.8-22	0.3 m (1.0)	21×14cm	350g (12.3)	57mm	70mm	49mm	Screw-in	○				
AUTO.	3.5-22	0.23m (0.8)	72×48mm	200g (7.1)	40mm	60mm		—	○				
MANUAL	3.5-16	0.13m (0.4)	max. 8×5mm min. 3×2mm	50g (1.8)	20mm	26mm					21mm Slide-on (Polarizing filter only)		
MANUAL	3.5-16	0.16m (0.5)	max. 20×13mm min. 6×4mm	70g (2.5)	28mm	37mm					32mm Slide-on (Polarizing filter only)		
MANUAL	4-22	0.35m (1.1)	max. 72×48mm min. 18×12mm	200g (7.1)	46mm	59mm		—					



MOTOR DRIVE GROUP

Designed specifically to match the OM-1, the Motor Drive Group has been reduced in size to enhance its maneuverability and ease of operation. The handgrip type motor drive provides a built-in shutter release device making it so compact the photographer can even hand-hold a 300mm telephoto lens for shooting sports or other action subjects. A 250 exposure roll film back and other units attach to the OM-1 without cords. This motor drive group is also a convenient accessory when used with other groups for close-up macrophotography, photomicrography, etc.

The Motor Drive Group consists of a number of units for sequential exposures in all types of photography. A remote control mechanism can be used for a series of exposures in short time period exposures taken intermittently in conjunction with a timer, or a series of exposures with bulk film. Framing speeds range from one frame every 3 seconds to 4 frames per second.

The Motor Drive Group can be easily attached to the OM-1 at any Olympus authorized service center.





CHART OF MOTOR DRIVE GROUP

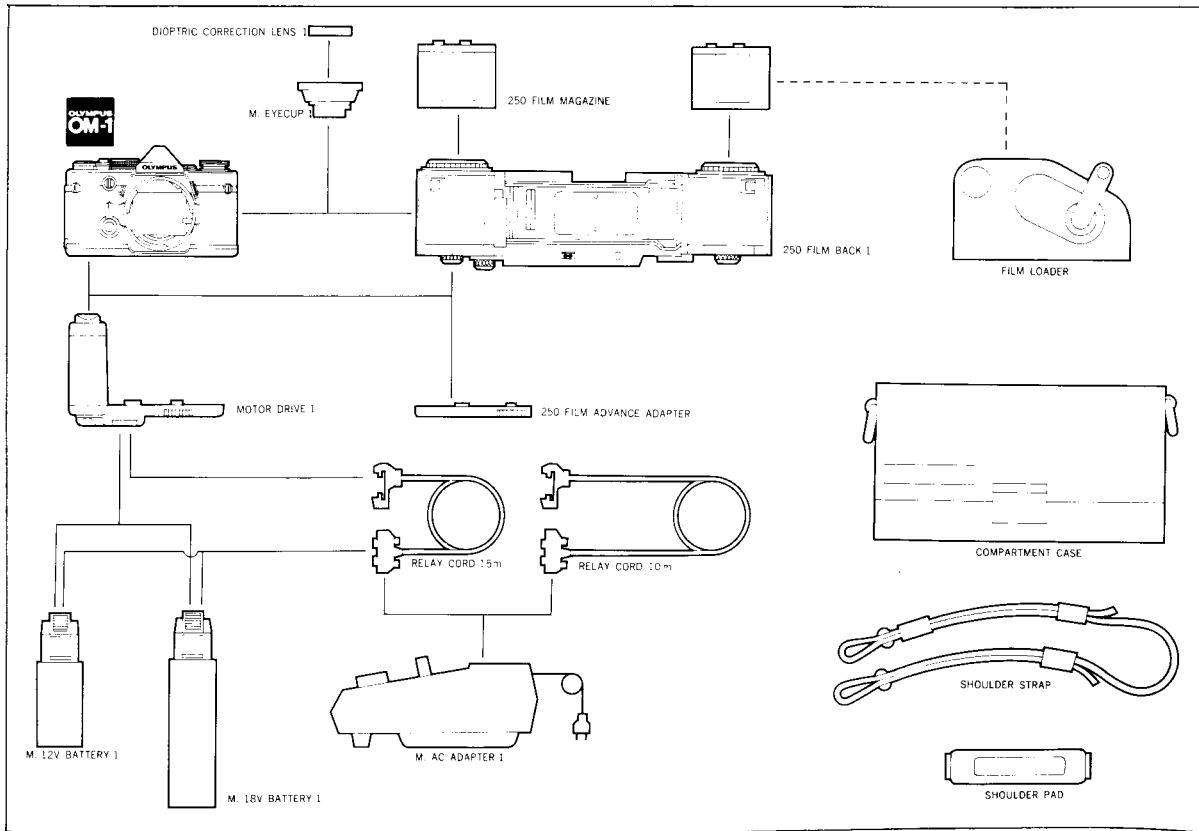

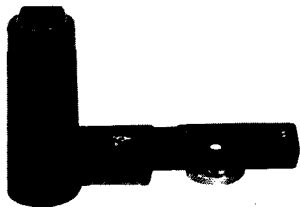

■ Motor Drive 1

Directly connects to the OM-1 using the tripod socket. Operating on various power sources including 12V DC and AC (household current), it has variable framing speeds from a single frame every 3 seconds to 4 frames per second.



■ 250 Film Back 1

Can be quickly attached to the OM-1, and used with Motor Drive 1 and 250 Film Advance Adapter for roll film up to 250 exposures (10m or 33 1/3 feet long).

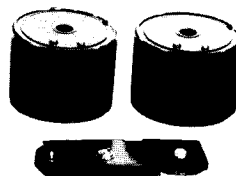

■ 250 Film Magazine

Makes loading a 250 exposure roll of film into the 250 Film Back 1 convenient, quick and easy.

■ 250 Film Advance Adapter



■ M.12V Battery 1

A power pack that accepts eight 1.5V batteries. Conveniently attached to OM-1 handgrip. Complete with a built-in release button and timer for intermittent or continuous exposures.

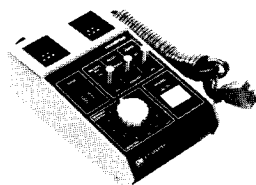

■ M.AC Adapter 1

AC transformer element for use with household current. Incorporates a selector switch between single-frame operation and sequential exposure operation, terminals for relay cord and timer for sequential exposures.

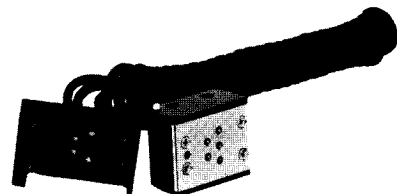

■ Relay Cords, 1.5 and 10m

Extension cord for remote control; one is 1.5 meters (4'11") long, the other 10 meters (32'9 3/4") long.



CLOSE-UP PHOTOGRAPHY GROUP

A single lens reflex camera is probably the most convenient method of taking pictures at close range. You view the subject directly through the lens for accurate focusing and the ultimate in composing ease. With the standard lenses, the OM-1 lets you take pictures as close as 45cm (17¾") from the subject. Close-up accessories help you get even closer, enabling you to take life-size and even larger-than-life size pictures. The Close-up Photography Group includes close-up lenses, extension tubes, and macro lenses that enable you to focus even closer. The extension tube 25 and macro lens 50mm enables you to achieve a 1:1 (life-size) close-up. The convenient macrophoto stand facilitates your close-up photography. The portable copy stand holds light sources on arms that can move to any angle and direction.

The bellows further enables you to delve deeper into the world of close-ups with maximum ease and remarkable results. The copy stand is ideal for all types of close-up applications including copying or photographing documents, books, biological or medical specimens and small mechanical components.





CHART OF CLOSE-UP PHOTOGRAPHY GROUP

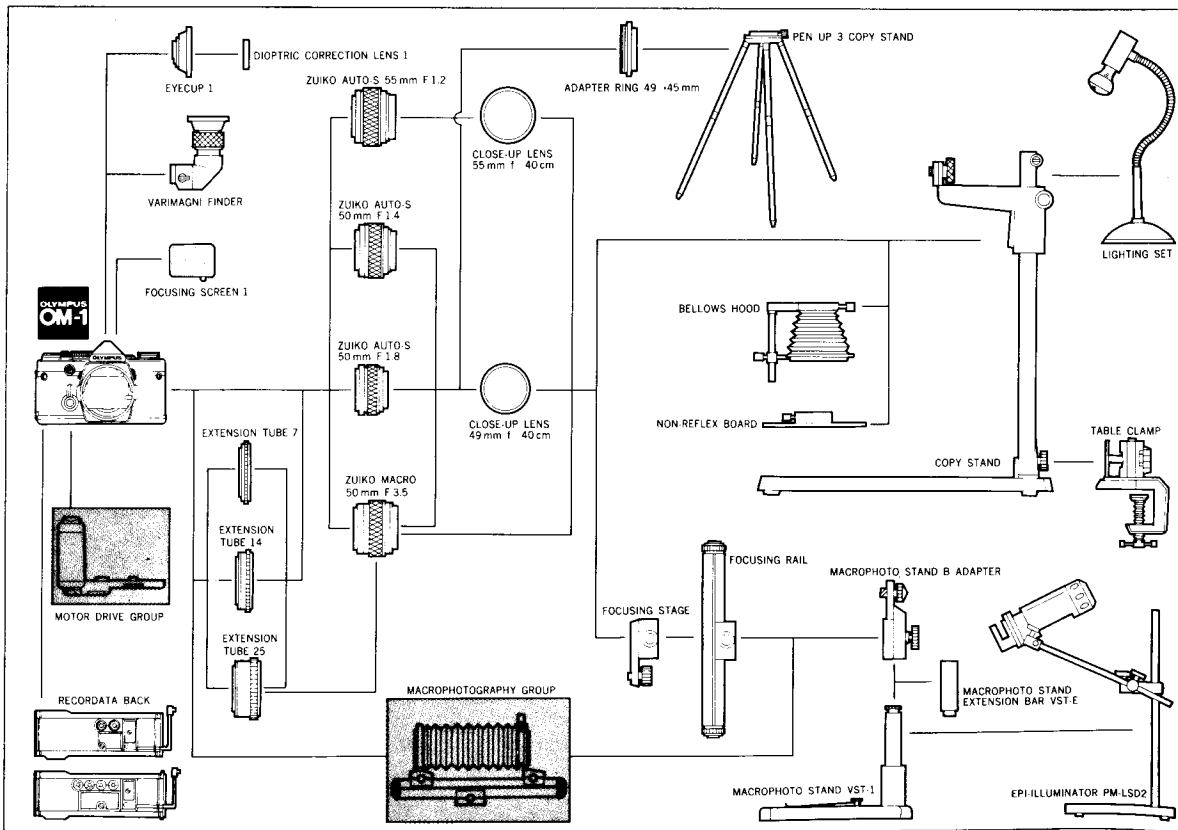



- Close-up Lens 49mm f=40cm
- Close-up Lens 55mm f=40cm

These attachment lenses provide the most economical method of taking close-ups. When used with the standard lenses, they enable the photographer to focus as close as 19cm (7 3/8").



- Extension Tube 7
- Extension Tube 14
- Extension Tube 25

These bayonet type extension tubes may be used alone or in combination to achieve seven different extension possibilities. When used with the stand-



25



14

ard F1.8 lens, subject-to-lens distances can be continuously varied from 39.1cm (15 1/4") to 6.8cm (2 5/8"). When used with the macro 50mm, the extension tube 25 provides an extended magnification range from 0.5X to life-size.

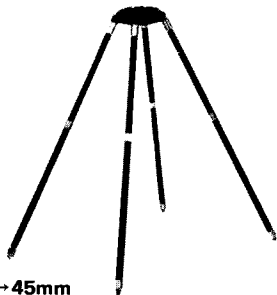

- Adapter Ring 49 → 45mm

Designed to adapt the 4 standard lenses including macro 50mm to the Pen Up 3 Copy Stand.

- Pen Up 3

A convenient portable copy stand which permits close-up photography with the OM-1 standard lenses. Com-

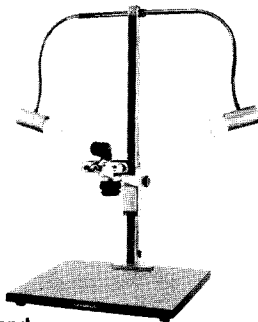

- Copy Stand

A versatile reproduction stand for use in copy and duplication photography.

Complete with a clamp for locking it in position, and 4 telescoping legs (calibrated in 3 steps).

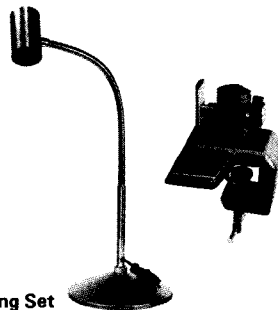

- Lighting Set

Complete with a pair of stable bases which attach to the copy stand and flexible light arms. Maximum light intensity is 500W, with adjustments to any angle or direction.

- Table Clamp

Extreme close-up and macrophotography overcomes the limitations of human vision. Tiny objects imperceptible to the human eye can be captured on film, revealing a miraculous new world of exciting shapes and colors.

The Macrophoto Group of the OM-System offers a complete range of convenient, high performance accessories designed for specialists in the various fields of macrophotography. Starting with 5 macro lenses, auto bellows and macrophoto stands and extending to a large variety of holders and frames, lighting equipment, etc., it is the world's most comprehensive and versatile system.

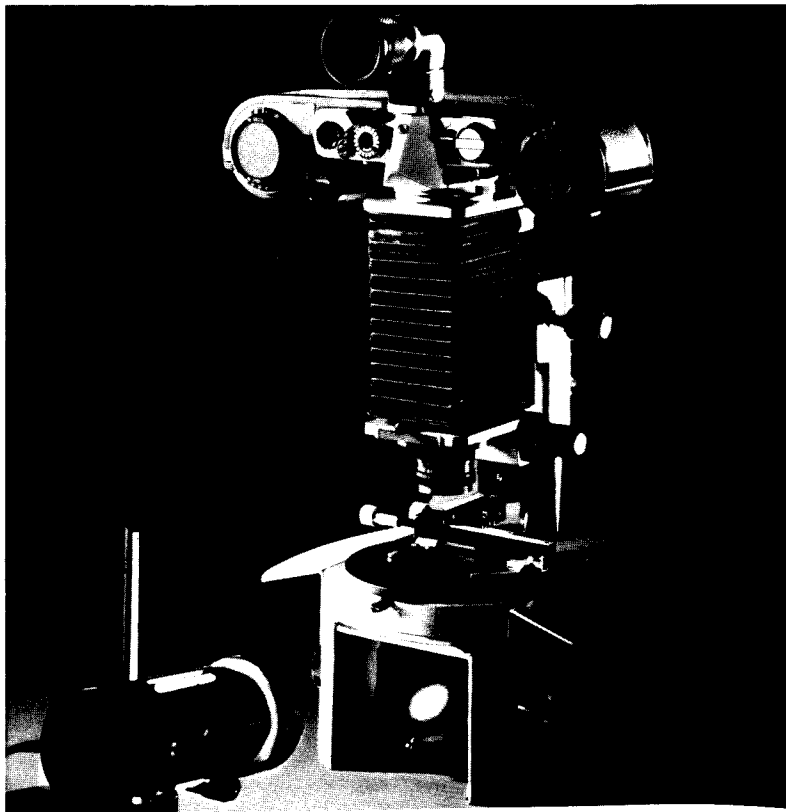
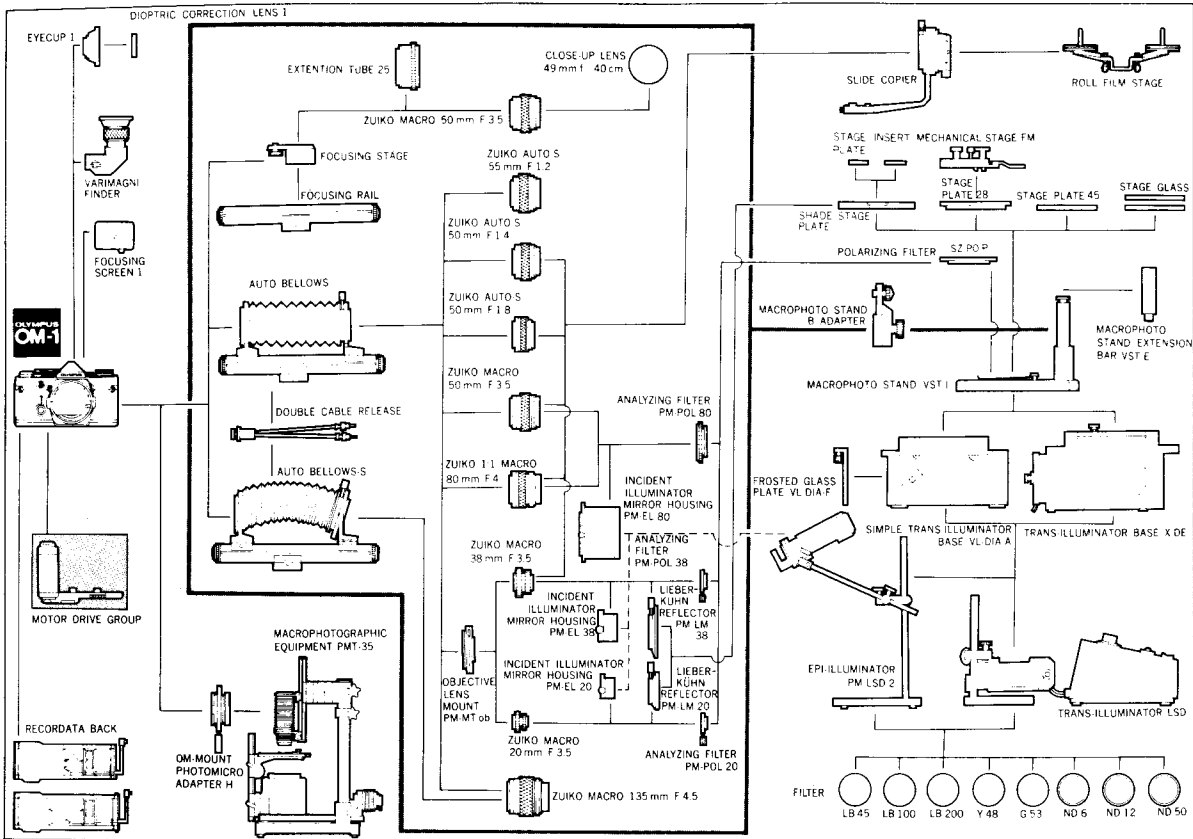
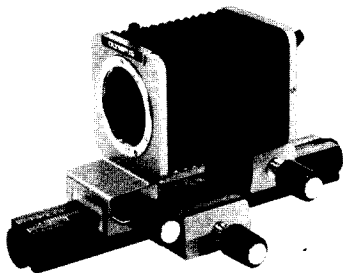



CHART OF MACROPHOTOGRAPHY GROUP





■ Auto Bellows

A versatile, precisely constructed bellows system including the bellows section, the focusing rail, and the focusing tripod mount. Provides separate magnification and focus adjustments.



■ Double Cable Release

Designed to be used with the auto bellows for synchronized operation of the diaphragm and shutter release. Ring timer is provided for long-time exposure.

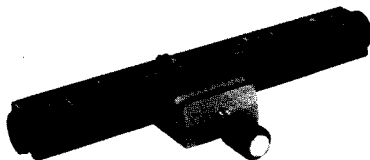

■ Focusing Rail

Specially designed for use with the focusing stage when mounted on the copy stand or microphoto stand B adapter. This unit is available together with the focusing rail.

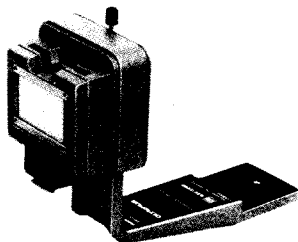

■ Slide Copier

For use with the bellows to copy transparent subjects in color or black and white. A film slide or strip is placed behind the detachable diffusion glass on the copier.

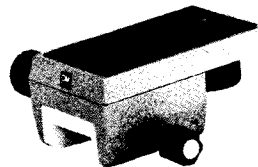

■ Focusing Stage

The focusing stage allows you to mount the camera on the focusing rail. When used with the rail, the stage makes it easier to shift the camera in the back-and-forth and right-and-left directions.

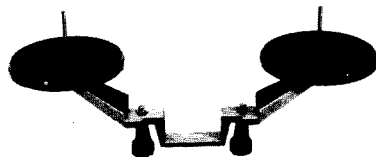

■ Roll Film Stage

A convenient accessory when using the bellows and slide copier for duplicating roll film. Any long roll of film, ready to curl up, is easily handled without a fear of scratching the film surface.

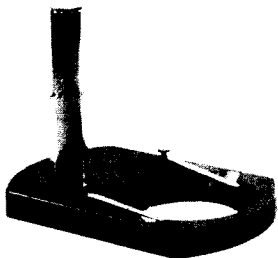

■ **Macrophoto Stand VST-1**

Designed for use with the trans-illuminator base for photography with transmitted light. Equipped with a round frosted stage (black at back) for incident light and a pair of film holders.

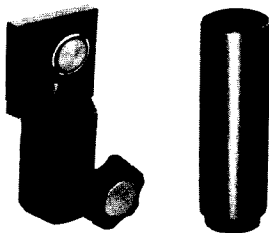

■ **Macrophoto Stand B Adapter**

Specially designed for use with the macrophoto stand. Clamped on the post of the stand, and supports the bellows or focusing rail.

■ **Macrophoto Stand Extension Bar VST-E**

When the post of the macrophoto stand does not reach a desired height, this extension bar can be easily attached to the post.



■ **Simple Trans-Illuminator Base VL-DIA-A**

This illuminator base is indispensable for holding the microphoto stand in close-up and macrophotography. It provides transmitted light from below a transparency for clearer photography. Provided with a built-in mirror and metal handrests for convenient operation.

■ **Frosted Glass Plate VL-DIA-F**

This plate is placed on the trans-illuminator base VL-DIA-A to offer diffused light in conjunction with the LSD trans-illuminator.

■ **Trans-Illuminator Base X-DE**

Made almost same as the VL-DIA-A except for wooden handrests and built-in 100V, 20W trans-illuminator.

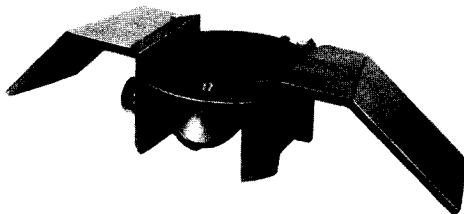

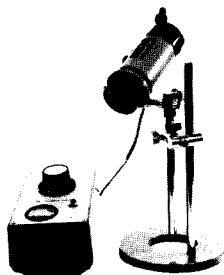

■ Epi-Illuminators PM-LSD 2

This pair of illuminators offer vertical illumination essential to macrophotography. When used with the incident illuminator mirror housing PM-EL, the illuminator supplies incident light through the half mirror. Focusing is adjustable by shifting the bulb filament. A 6V to 8V variable transformer is provided. Eight filters are available in various sizes, including color, black and white, neutral density, etc.

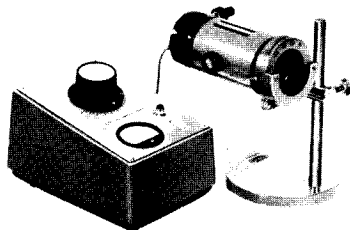

■ Trans-Illuminator LSD

The LSD is a universal type trans-illuminator for use with the X-DE and VL-DIA-A trans-illuminators for macrophotography. When the Lieberkühn reflector is added, vertical light is also available. A 6V, 30W bulb is built-in. The condenser travels 18mm by rack and pinion for converging, diverging and parallel adjustments of light. Complete with transformer and square filter 60x 45C.

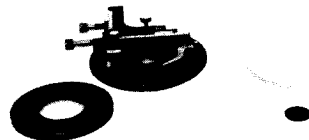

■ Stage Glasses (clear and frosted-and-black)

■ Stage Plate 45 (metal disc, black finish)

■ Stage Plate 28 (metal disc, black finish)

■ Glass Shade Stage Plate

Supplied with two stage insert plates and compatible with the Lieberkühn reflector. A 25mm diameter port in the center accepts the stage insert plate on which a subject is placed.



■ Filters

Eight filters are available for use with either the LSD or PM-LSD2 illuminators. These include blue filters for

color temperature compensation, yellow and green filters for monochromatic contrast and ND filters for light density adjustment.

■ Mechanical Stage FM

This mechanical stage is used to mount subjects on the 28mm stage plate. The subject travels vertically and horizontally by fine adjustments with vernier.



■ Polarizing Filter SZ-PO-P

A polarizing filter can darken blue skies without affecting the rendition of colors or contrasts in your subject. It is mounted on the stage of the macro-photo stand, compatible with PM-POL.



■ Lieberkühn Reflectors PM-LM20 and 38

Two Lieberkühn reflectors are available for use with the 20mm and 38mm macro lenses. When used with the LSD trans-illuminator, they make it possible to take photographs with surprisingly good penetration and lack of shadows.



■ Incident Illuminator Mirror Housings PM-EL 20, 38 and 80

These illuminators are used with Zuiko macro lenses. The 80mm and 50mm macro lenses are used with the illuminator PM-EL80 and the 38mm and 20mm macro lenses are used with the illuminators PM-EL38 and PM-EL20 respectively. A half-mirror built in the housing reflects light coming from the light source into a port in the housing bottom to evenly illuminate the subject.



■ Objective Lens Mount PM-MTob

This objective mount enables you to mount the Zuiko macro 20mm and 38mm to the auto bellows.

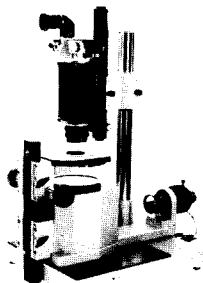

■ Macrophotographic Unit PMT-35

The PMT-35 is a complete macro-photographic system for OM-1 photo work providing image magnification from 0.45x to 16.5x. A macrophoto mount adapter connects OM-1 to the supporting arm. The built-in shutter has shutter vibration prevention. Shutter speeds range from 1 second to 1/500 second with T and B, and M-X synchronizing contacts.

■ Analyzing Filters PM-POL 20, 38 and 80

The filters are placed between the film and the light source on the macro-photo stand stage. Compatible with the polarizing filter SZ-PO-P for photography with transmitted light.

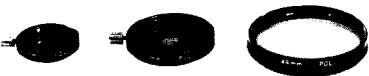

When photographing microscope images of more than 10x, it becomes increasingly difficult to take quality pictures. Photomicrography has spread not only into the scientific fields (used in medical, biological, chemical, botanical and zoological sciences for recording observations and illustrating scientific publications) but also is now used in the artistic fields of graphic design, commercial photography, displays, etc. In industries such as foods, textiles, metal and so forth, photomicrography is of great value. Higher magnification photography (over 10x power) requires extremely precise photomicrographic equipment and the OM-1 offers an unusually wide range of photomicrographic units. The Photomicrography Group include the photomicroscopic adapters, the 35mm SLR camera adapter, the exposure meter EMM-6, the automatic exposure control box PM-CBA, the supporting stand PM-PSS, eyepiece adapters, and magnifiers. All of these are specifically designed to produce photomicrographic results with maximum ease of operation. In addition, to these units, the group also includes adapters for endoscope, stereoscopic operation microscope and eye fundus camera.

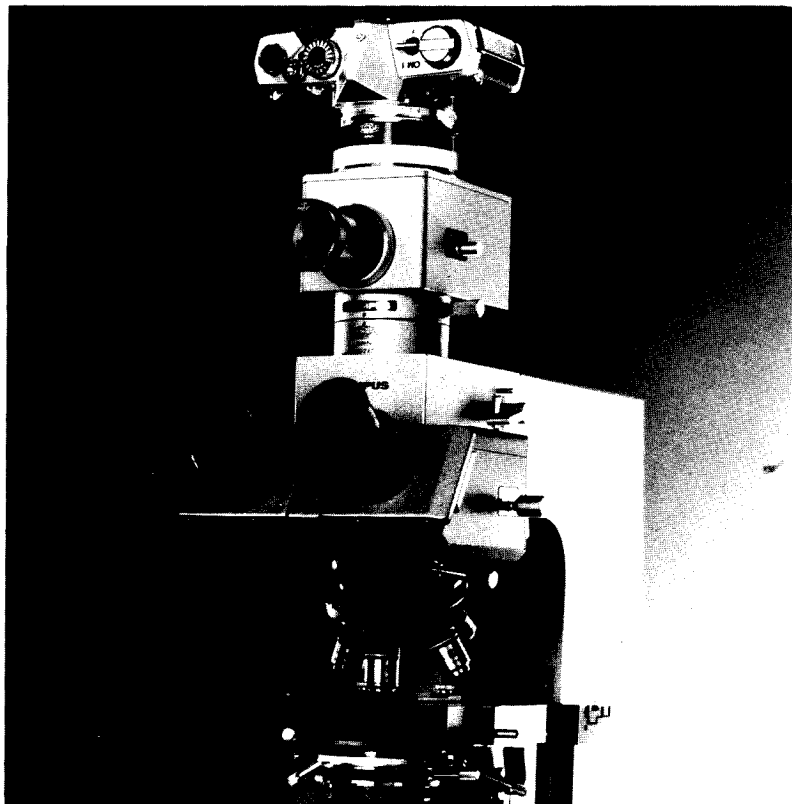
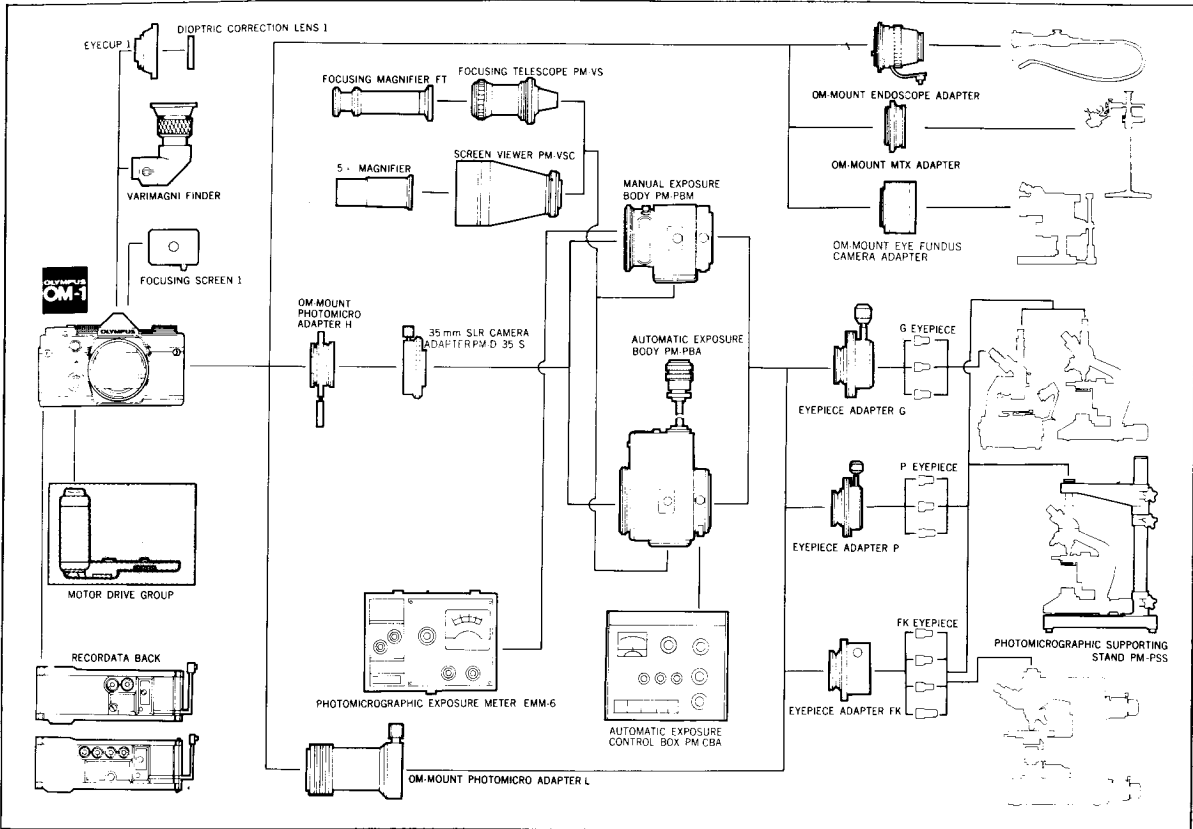

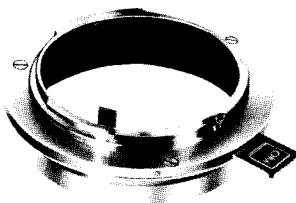

CHART OF PHOTOMICROGRAPHY GROUP





■ **OM-Mount Photomicro Adapter L.**
 Connects the OM-1 body with the microscope ocular for low power magnification.



■ **OM-Mount Photomicro Adapter H**
 Connects the OM-1 to the automatic exposure body PM-PBA, manual exposure body PM-PBM, or photomicrographic unit PMT-35.

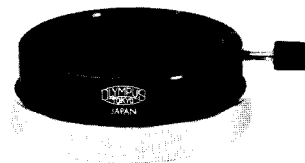

■ **35mm SLR Camera Adapter PM-D35S**
 Used with OM-Mount Photomicro Adapter H to attach the OM-1 to the PM-PBA or PM-PBM.

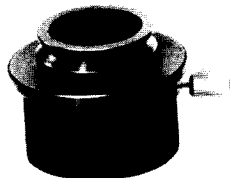

■ **Eyepiece Adapter G**
 ■ **Eyepiece Adapter P**
 ■ **Eyepiece Adapter FK**

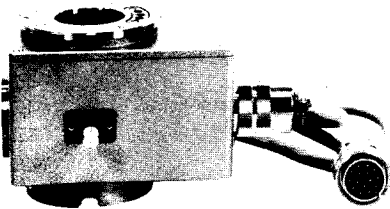

■ **Automatic Exposure Body PM-PBA**

Automatically determines correct exposure time and advances film after each exposure. A built-in CdS meter reads light directly through the eyepiece and selects correct exposure between 1/100 second and 32 minutes for color and black-and-white films, automatically compensating for reciprocity failure. Used in combination with the PM-CBA.

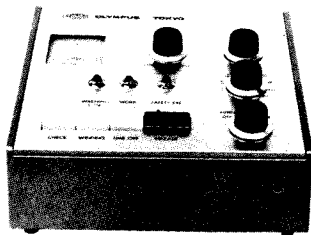

■ **Automatic Exposure Control Box PM-CBA**

Used with the automatic exposure body PM-PBA, this meter permits light balancing to obtain correct color temperatures by means of zero point alignment compensating for reciprocity failure. Eight filters are included.

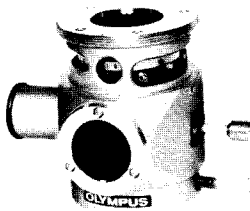

■ **Manual Exposure Body PM-PBM**

A bayonet mount permits convenient, rapid interchange of camera backs for black-and-white and color work. A shutter release button is integrated to eliminate shutter vibration. A light measuring port is provided for the use with EMM-6 exposure meter to obtain exact exposure time, if desired.

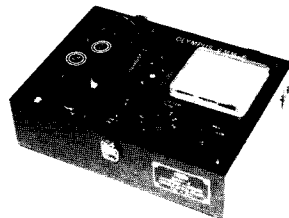

■ **Photomicrographic Exposure Meter EMM-6**

The EMM-6 assures accurate control of both exposure and color temperature in photomicrography. The EMM-6 comes in a polished wooden cabinet with exposure and color temperature probes, color-compensating filters and an adapter for use with ground-glass cameras (viewing or reflex type).

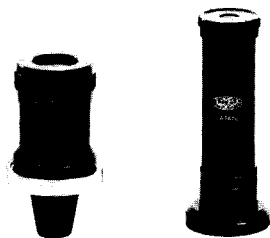

■ Focusing Telescope PM-VS

Select a reticle compatible with your film size in use with the PM-PBA and PM-PBM.

■ Focusing Magnifier FT

A slide-in front lens assembly that can be moved laterally to permit focusing on the frame reticles of the focusing telescope.



■ Screen Viewer PM-VSC

Clamped to the automatic exposure body for use with 4x or lower objectives.

■ 5X Magnifier

Front lens assembly can be moved in and out to focus on the cross line of the frosted glass screen viewer.

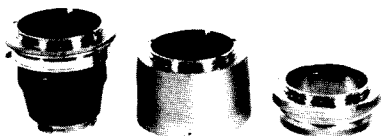

■ OM-Mount Endoscope Adapter (for Olympus fiberscopes)

■ OM-Mount Eye Fundus Camera Adapter (for Olympus eye fundus camera)

■ OM-Mount MTX Adapter (for Olympus Stereo Operating Microscope MTX)

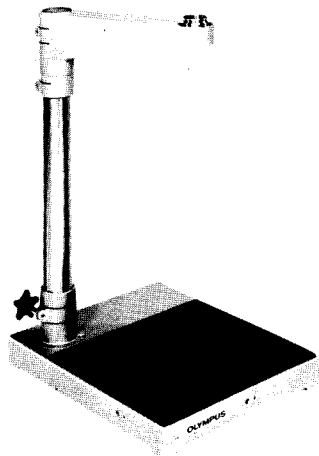

■ Photomicrographic Supporting Stand PM-PSS

The PM-PSS is a massive new photomicrographic stand to virtually end the major cause of lost photomicrographs...vibration. Supports the entire weight of the camera, isolating it from the microscope. Other bench vibrations are absorbed by the stand's rubber feet.

CHART OF CLOSE-UP RANGES

PHOTOMICROGRAPHY (mm) 240 x 360 120 x 180 48 x 72
 RANGE (inch) (9 3/8 x 14 1/8) (4 3/8 x 7 1/8) (1 3/8 x 2 3/8)

24 x 36 12 x 18
 (1 2/8 x 1 3/8) (1/2 x 3/4)

4.8 x 7.2 2.4 x 3.6
 (高 x 高) (高 x 高)

MAGNIFICATION 1 1.10 1.5 1.2 1 2 5 10 20 50 100 200 500 1000 TIMES

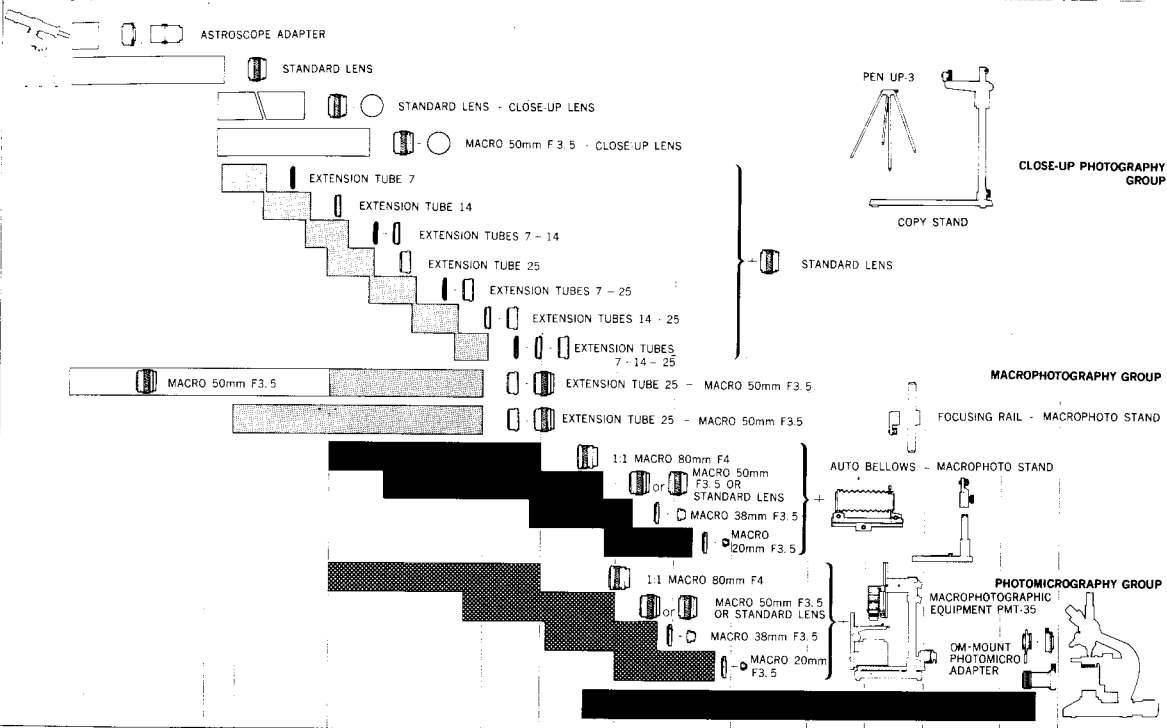

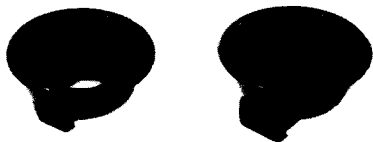

■ Eyecup 1

Designed to prevent glare and loss of contrast caused by stray light hitting the eyepiece. Made of rubber for soft touch on the forehead. A dioptic correction lens is fitted into a slot in the eyecup and held by a threaded retaining ring.

■ M. Eyecup 1

Attached on the viewfinder and used in conjunction with the 250 film back 1 for motor drive photographing.



■ Dioptic Correction Lenses

An aid to easier focusing with far-sighted or near-sighted vision. These lenses snap into slot provided in the camera eyepiece. They are available in 8 different diopter strengths: +2, +1, 0 diopters for far-sighted; -1, -2, -3, -4 and -5 diopters for near-sighted.

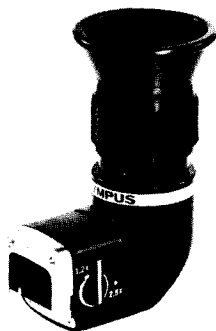

■ Varimagni FINDER

This is a deluxe combination of an angle finder and a magnifier incorporating 9 lens elements and reflector. It rotates 360°, allowing you to focus from any position. It can be adjusted for individual eyesight. Images reflected on the finder glass can be changed from 1.2x to 2.5x magnifications by selector switch.

Ideal for use with copy stands, bellows, microscope adapter, or with camera alone in any situation calling for waist-level or right angle viewing.

■ Astroscope Adapter

This adapter connects the OM-1 to an astronomical telescope.



■ Filters

In general photography and in many specialized fields, filters are essential to the effective rendition of photographic subjects. Whether in black and white or color, filters are necessary additions to most camera systems. In controlling contrast and eliminating unwanted haze in black and white photography, the use of the correct filter often means the difference between a good photograph and a great one. In color, where the balancing of the light with the film emulsion is absolutely necessary for correct color, conversion and light balancing filters are the only effective way of achieving the desired results. Olympus filters are made of the highest quality optical glass and are tested to the same high standards used in evaluation of Zuiko lenses. All extraneous lights and aberrations have been eliminated so as not to affect focusing quality of any lens with which the filter is used, and all Olympus filters are fully coated on both sides to minimize flare and reflection.

Name	Color	Descriptions
Y48 (Y2)	Yellow	Accentuates contrast, darkens blue skies. Very effective in daylight scenes where the sky is part of subject matter. Heightens the effect of white clouds. Useful in copying documents where line copy is blue or black on light background.
O56 (O2)	Orange	Absorbs a wider range of wavelengths from UV to dark green than the Y2. Makes a superb rendition of the texture of outdoors subjects, and indoors. It brings out detail in objects yellow, brown. Used with infrared film.
R60 (R1)	Red	Used as contrast filter to create darkened sky or in copying. Also used to penetrate haze in landscape photography for stronger contrast than an O2 filter. Used with infrared film.
Skylight (1A)	Colorless	Similar to UV filter. Eliminates ultraviolet rays. Reduces haze and bluish tones in daylight photography. Effective with color film only. May be used at all times to protect the lens.
L39 (UV)	Colorless	Eliminates undesirable ultra-violet rays which cause dull, flat pictures. Renders subject in clear, detailed brilliance. May be used at all times to protect the lens.
ND2 ND4	Grey Grey	Reduces the quantity of light entering the lens to 1/2 or 1/4 of the original intensity. For use in extremely bright conditions when you wish to maintain a wide aperture.
Polarizing filter POL	—	Enables you to take pictures through glass or water without reflections. Will darken the sky in black-and-white photographs without altering other color values in the picture, and renders blue skies darker when used with color film. Reflections are reduced to provide better texture surface detail.
A4 (81C)	Amber	For use when taking color pictures in cloudy or rainy weather. Reduces bluish tone.
B4 (82C)	Blue	Designed for use when taking color pictures in early morning or late evening hours when red rays are predominant.

OM
SYSTEM

OLYMPUS

OLYMPUS OPTICAL CO., LTD.
43-2 Hatagaya 2-chome, Shibuya-ku, Tokyo, Japan