

OLYMPUS®



AZ-220 WIDE ZOOM

■ INSTRUCTIONS

- Before using your AZ-220 WIDE ZOOM, read this manual carefully to ensure correct use.
- We recommend that you take test shots to get accustomed to your AZ-220 WIDE ZOOM before taking important photographs.

ADVANCED
TECHNIQUES

CAMERA
MAINTENANCE

Thank you for purchasing the Olympus AZ-220 WIDE ZOOM.

MAIN FEATURES

- Built-in 28mm~56mm 2X zoom lens: 28mm is perfect for scenery shots, while 56mm is ideal for quick snaps.
- Panorama* mode can be selected even in the middle of a loaded cartridge of film.
- Versatile, easy-to-use functions include continuous shooting, spot metering and various flash modes.

*Be sure to read page 27 for Panorama-size prints.

Symbols used in this manual:

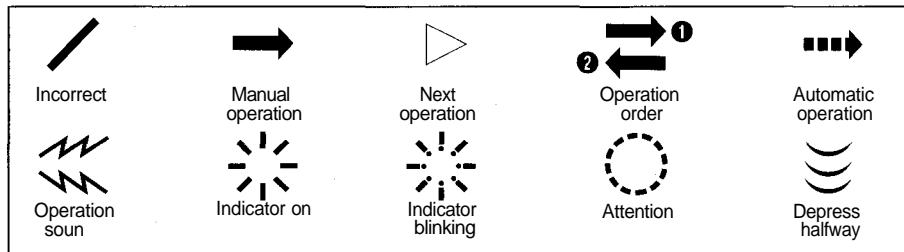

PREPARATIONS

Names and functions of parts.....	4	Outline of operations.....	10
Viewfinder display/LCD panel.....	6	Loading the batteries.....	12
Diopter adjustment.....	7	Checking the batteries.....	13
Using the strap.....	8	Points to remember.....	14

BASIC OPERATIONS

Loading the film	16
Taking pictures.....	18
Using the focus lock.....	22
Unloading the film	24

ADVANCED TECHNIQUES

Taking Panorama pictures.....	25	Continuous shooting.....	34
Flash photography.....	28	Dual-frame self-timer.....	35
Using the SUBJECT button.....	32	Spot metering.....	36
Self-timer.....	33		

CAMERA MAINTENANCE

Questions and answers.....	38
Care and storage	39
Battery handling.....	40
Troubleshooting.....	41
Specifications.....	43

NAMES AND FUNCTIONS OF PARTS

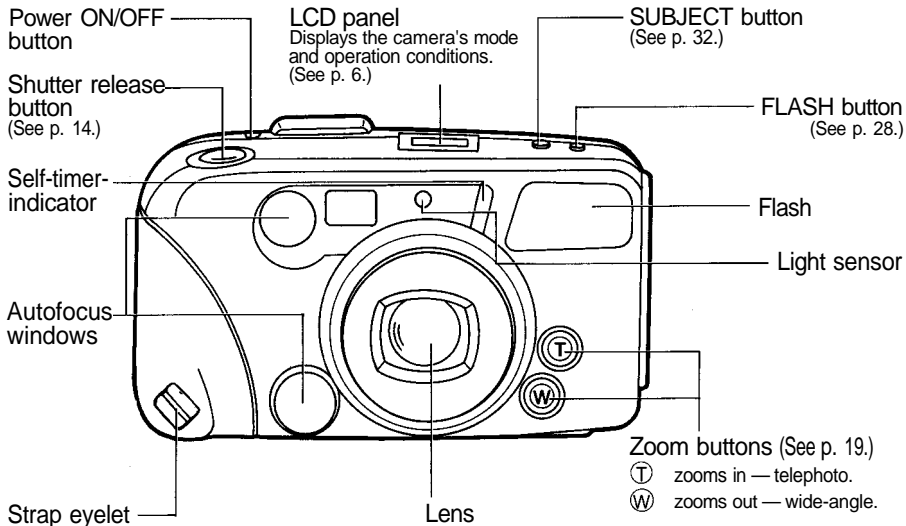

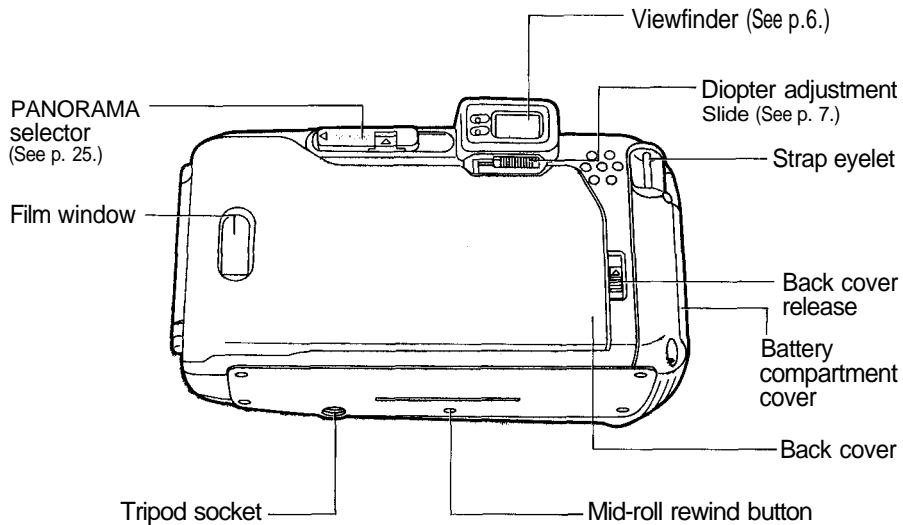

VIEWFINDER DISPLAY/LCD PANEL

VIEWFINDER DISPLAY

In Standard mode

Close-up correction marks

At a distance of 0.65 m (2.1 ft); your subject must be positioned within the close-up correction marks.

In Panorama mode

Close-up correction marks

Orange lamp
Lights when the flash will fire.

Green lamp
Lights when the subject is in focus.

Autofocus frame
Position your subject within the autofocus frame.

LCD PANEL

Flash modes (p. 28)

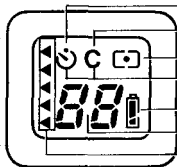
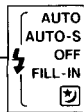

Self-timer (p. 34)

Continuous mode (p. 34)

Spot mode (p. 34)

Dual frame self-timer mode (p. 35)

Battery check (p. 13)

Exposure counter (p. 17)

Flash mode selection (p. 28)

DIOPTER ADJUSTMENT

TO ADJUST THE VIEWFINDER TO COMPENSATE FOR NEAR AND FARSIGHTED VISION.

Slide the diopter adjustment slide until the viewfinder display becomes clear.

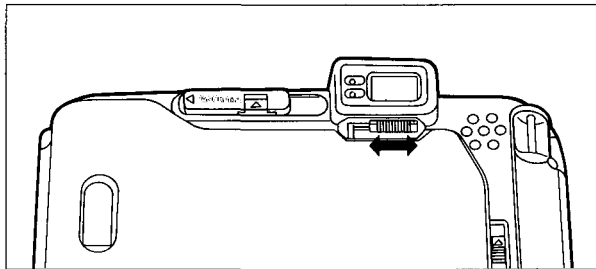

Slide to the left if you are farsighted or to the right if you are nearsighted.

USING THE STRAP

ATTACHING THE STRAP

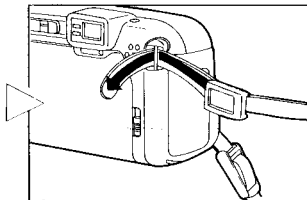
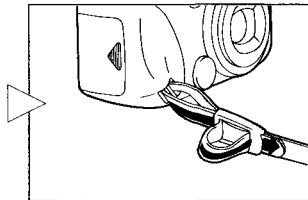
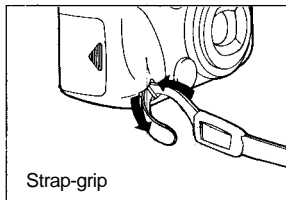

For a more comfortable, secure grasp of the camera, place the strap-grip as close to the camera as possible.

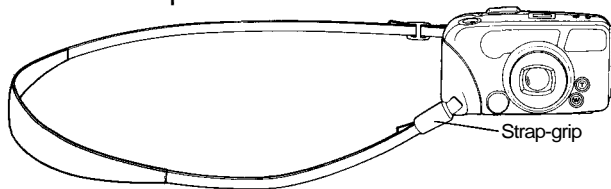
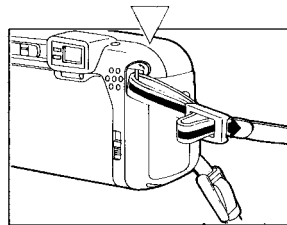

SOFT CASE (optional)

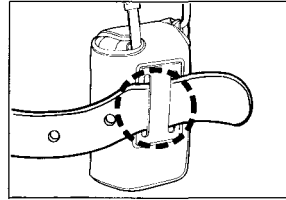
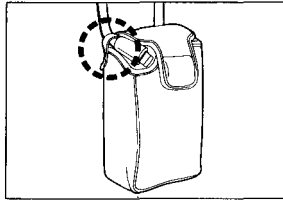
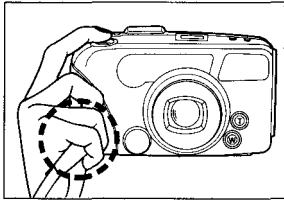

When you aim the camera, hold the strap-grip as shown above.

OUTLINE OF OPERATIONS

BASIC SHOOTING PROCEDURES

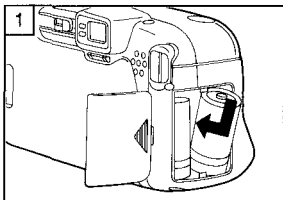

Load the batteries. (p. 12)

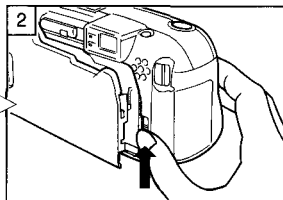

Open the back cover. (p. 16)

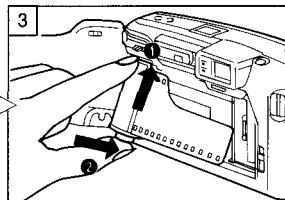

Load the film. (p. 16)

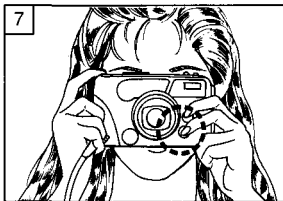

Press the zoom buttons to make the subject larger or smaller. (p. 18)



Place the autofocus frame on the subject you want to take a picture of. (p. 19)

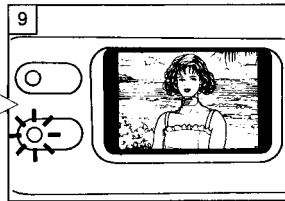

Depress the shutter release button halfway to make sure the green lamp lights. (p. 20)

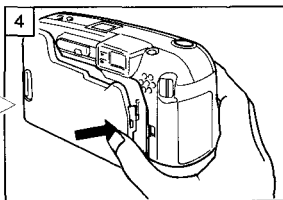

4 Close the back cover. (p. 17)

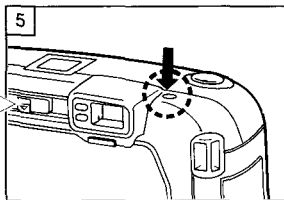

5 Press the ON/OFF button to turn the power ON. (p. 18)



6 Make sure the exposure counter on the LCD panel reads 1. (p. 17)

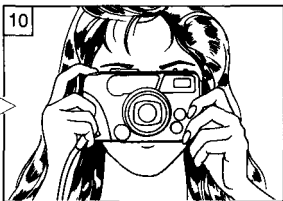

10 Depress the shutter release button fully to take a picture. (p. 20)

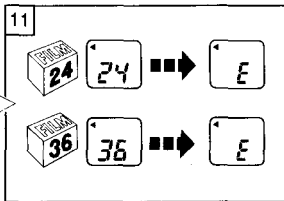

11 When the film reaches the end, it is automatically rewound. (p. 24)

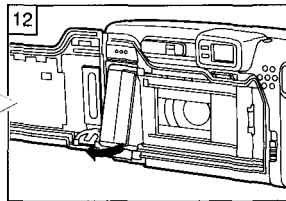

12 Open the back cover to remove the film. (p. 24)

LOADING THE BATTERIES

1. Remove the battery cover.

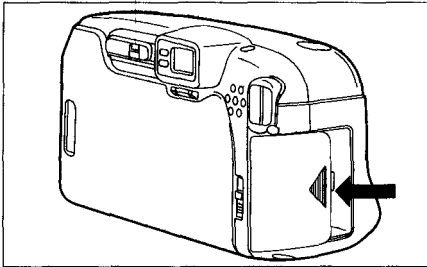

- Use two 3V lithium batteries (CR123A or DL123A).

2. Insert the batteries and replace the battery cover.

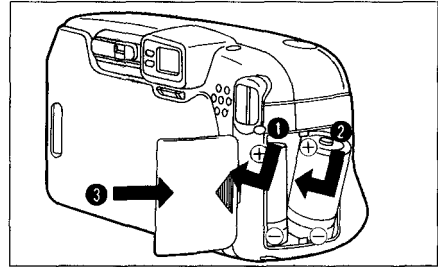





- Be sure the batteries are aligned correctly as shown.

Read "Battery handling"
on page 40

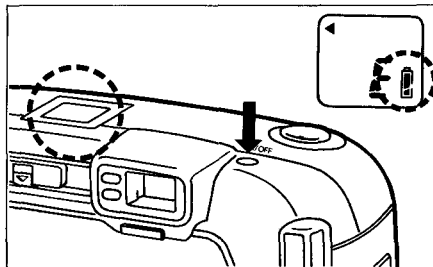
CHECKING THE BATTERIES

1. Press the ON/OFF button to turn the power ON. Be sure to check the batteries as well.



	Batteries are OK. The mark disappears after 12 sec.
 Blinks	Batteries are low. Have spares handy.
 Lights	Batteries should be replaced immediately.

POINTS TO REMEMBER

Hold the Camera Correctly.

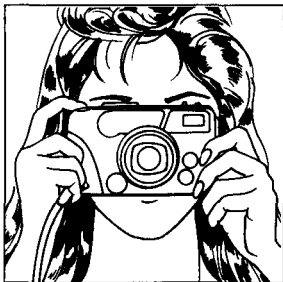

Correct.

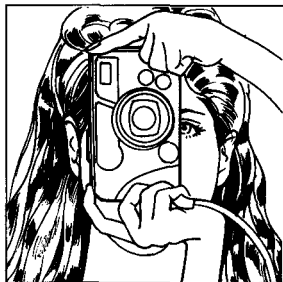

Correct.

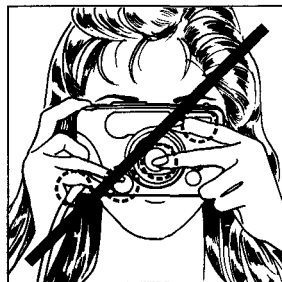

Incorrect.

- Hold the camera firmly with both hands.
- Hold the strap-grip as shown on page 9,
- In the vertical position, hold the camera with its flash positioned at the top.

Caution;
Keep your fingers away from the lens, flash, autofocus windows and light sensor.

Proper Shutter Release. Practice before loading the film.

1. Depress the shutter release button halfway

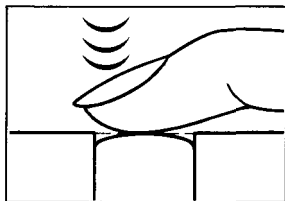

To lock the focus.

Make sure

The green lamp lights in the viewfinder.

2. Depress the shutter release button fully

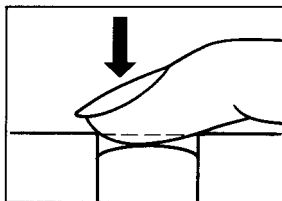

To release the shutter and take the picture.

Cautions:

- Press the shutter release button gently
- Avoid shaking the camera when pressing the shutter button to prevent blurry pictures.

LOADING THE FILM

1. Slide the back cover release upwards to open the back cover.

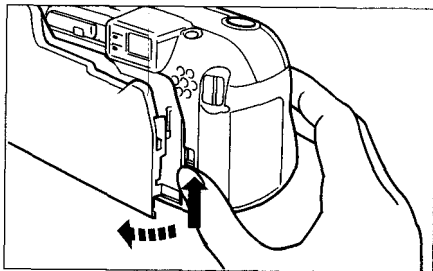

Do not touch the inside of the camera, especially the lens. If the lens is dirty, use a blower brush to blow away the dust and lightly wipe off the lens with a soft cloth.

2. Insert the film cartridge, making sure the film is lying flat.

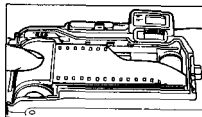
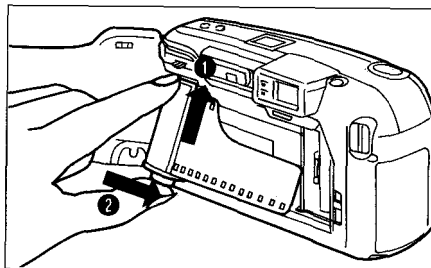

Correct

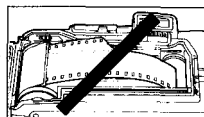

Incorrect

3. Align the film leader with the red mark, and close the back cover.

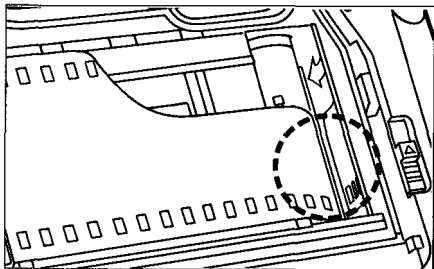

The film automatically advances to the first frame.

4. Press the ON/OFF button to turn the power ON.

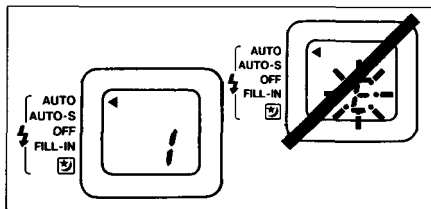

Make sure

The exposure counter on the LCD panel reads !

Note:

If **E** blinks in the exposure counter, as shown above, reload the film.

TAKING PICTURES

1. Press the ON/OFF button to turn the power ON.

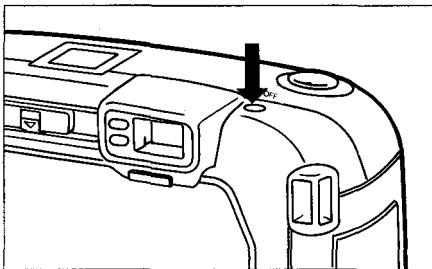

2. Aim the camera at your subject. Use the zoom buttons to make the subject larger or smaller.

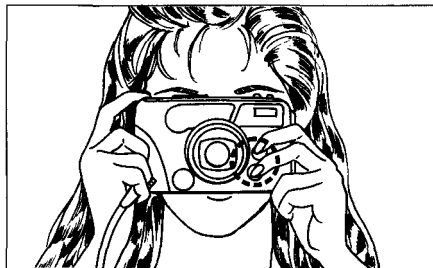

Make sure

The lens protector opens, the lens extends slightly, and the LCD panel activates.

How to Use the Zoom Buttons

Telephoto: Press the  button to zoom in.



Max. telephoto focal length: 56 mm

Wide-angle: Press the  button to zoom out.



Max. wide-angle focal length: 28mm

3. Position your subject within the autofocus frame.

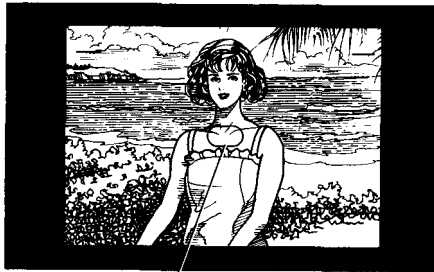

Autofocus frame

4. Depress the shutter release button halfway.

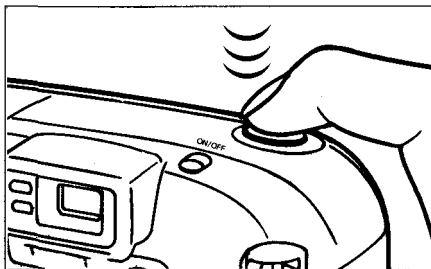

Make sure
The green lamp lights.

5. Depress the shutter release button fully.

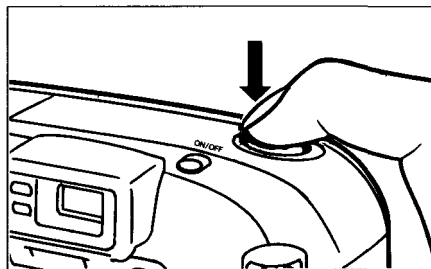

The film automatically advances to the next frame.

Working Distance

The focus range of the camera is 0.65 m (2.1 ft) to ∞ (infinity).

- When the subject is closer than 0.65 m (2.1 ft), the shutter will not release. (The green lamp blinks.)
- When the subject is extremely close to the camera, the subject will be out of focus although the shutter releases.

Close-Up Correction

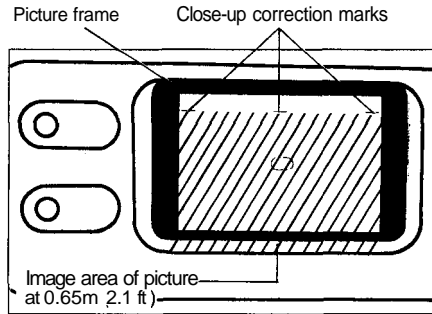



The viewfinder's picture frame is the area that can be shot of subjects at ∞ (infinity). However, the picture area will move lower in the viewfinder as you get closer to the subject. At 0.65 m (2.1 ft), the shaded area is the actual available image area. In this case, the subject should be positioned below the close-up correction marks.

USING THE FOCUS LOCK

TO AVOID TAKING OUT-OF-FOCUS PICTURES

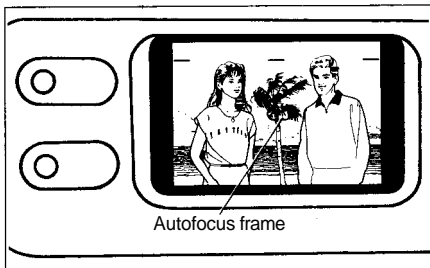
When the main subject is not in the center of the frame, use the focus lock.



The autofocus frame  must be positioned on the subject in order to focus on it. In the above case, the camera will focus on the tree in the background and the subjects will be out of focus.

1. Position the autofocus frame  on your subject and press the shutter release button halfway.

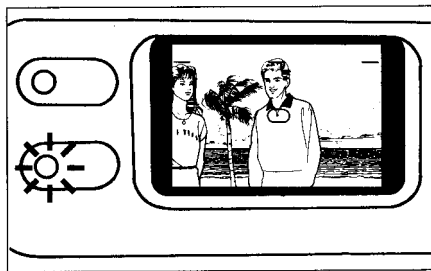

Make sure
The green lamp lights.



2. Reposition your subjects in the picture frame while keeping the shutter release button depressed halfway.

3. Depress the shutter release button fully to take picture.

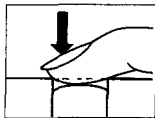
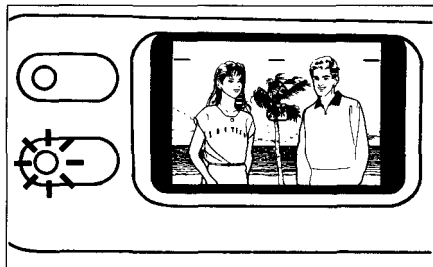

Difficult Autofocus Subjects

- Glossy and reflective surfaces
- Black objects
- Subjects behind glass or wire mesh
- Flames and smoke
- Excessively bright light within the picture area

In the above situations, use the focus lock by focusing on a different subject at a similar distance. Then reposition the correct subject in the picture frame.

UNLOADING THE FILM

The camera automatically rewinds the film when you reach the end of a roll.

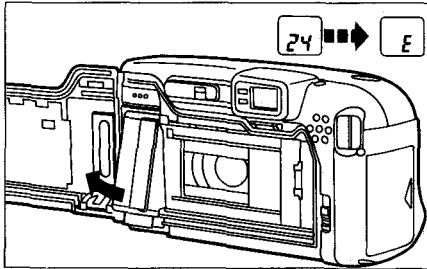

After the motor stops and **E** starts blinking on the LCD panel, open the back cover and remove the film.

Rewinding the film before the end of the roll

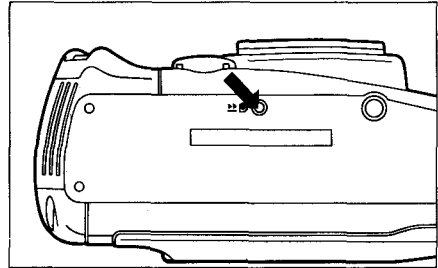

Press the mid-roll rewind button with the tip of a ballpoint pen, or the like. Do not use an instrument with a sharp tip.

TAKING PANORAMA PICTURES

To select the Panorama mode:
Slide the Panorama selector to the left.

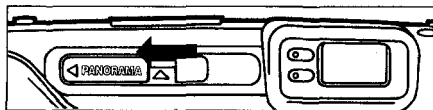

Viewfinder in the Panorama mode



To select the Standard mode:
Push upward the Panorama release. The Panorama selector slides back to the right.

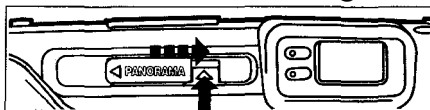

Viewfinder in the Standard mode



CLOSE-UP CORRECTION IN THE PANORAMA MODE

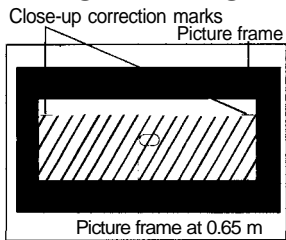

As you approach the subject, the available image area reduces.

At 0.65 m (2.1 ft), the subject must be positioned between close-up correction marks (the shaded area in the illustration) for satisfactory results.

PRINTING PANORAMA PICTURES

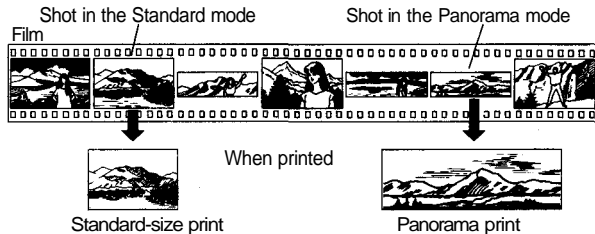

When Panorama pictures are shot, only the middle portion of the frame is exposed as shown. The number of exposures is the same as with the standard size.

IMPORTANT INFORMATION REGARDING PANORAMA-FORMAT PRINTS

There are three possible ways in which a roll of film may be taken:

- ① Shot only in the Standard mode
- ② Shot only in the Panorama mode
- ③ Shot in both the Panorama and Standard modes

With film taken as described in ② or ③, please be sure to inform your processing lab accordingly when you have your film developed.

- When pictures taken in the Panorama mode are printed in the standard size, black strips appear at top and bottom of prints as shown on right.
- Processing for ③ may be more expensive and may take longer than that for ②. Ask the processing lab for more details.
- Availability of Panorama format film processing facilities varies according to area. Consult your local film processor or camera dealer for details.





FLASH PHOTOGRAPHY

This camera has five flash modes. Select the flash mode according to your shooting conditions and needs.

How to select the flash mode:

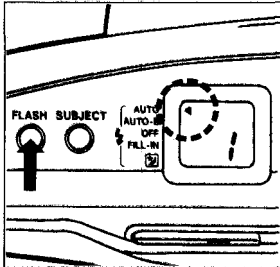
When the FLASH button is pressed, the flash mode changes in the order shown on the right. On the LCD panel, ◀ indicates the flash mode engaged.



Mode	Function
AUTO	Automatically fires in low-light and backlit conditions. (p. 29)
AUTO-S	Significantly reduces the phenomenon of "red-eye" (when a subject's eyes appear red). (p. 30)
OFF	The flash does not fire. (p. 30)
FILL-IN	Fires regardless of available light. (p. 31)
	When you want to light the subject in the foreground with a night-scene in the background. (p. 31)

Note: AUTO-S will not be canceled when the power is turned OFF. All other modes will return to the AUTO mode.

AUTO (Auto Flash Mode)

In the Auto Flash mode, the flash will fire automatically in low-light and backlit conditions. Use this mode in ordinary situations.

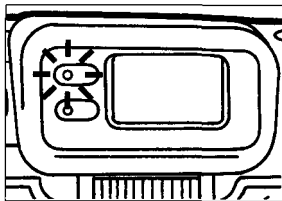

Make sure

The orange lamp on the upper left of the viewfinder lights when the shutter release button is depressed halfway.

Flash Working Range

ISO	WIDE (28mm)	TELE (56mm)
100	0.65m~5.3m (2.1ft ~17.4ft)	0.65m~2.8m (2.1ft~9.2ft)
200	0.65m~7.5m (2.1ft~24.6ft)	0.65m~4.0m (2.1ft ~13.1ft)
400	0.65m~10.6m (2.1ft~34.8ft)	0.65m~5.6m (2.1ft~18.4ft)

Note: If a backlit subject is too small or is not centered in the frame, occasionally the flash may not fire automatically. If this occurs, use the FILL-IN mode.

AUTO-S (Red-Eye Reducing Flash)

Significantly reduces the phenomenon of "red-eye" (when a subject's eyes appear red).

In the Auto-S Flash mode, the camera will emit a series of low-power pre-flashes before the regular flash. This makes the subjects' pupils contract, significantly reducing red-eye. Except for the pre-flashes, this mode is the same as the Auto Flash mode.



IMPORTANT: Be sure to hold the camera still until the shutter releases.

OFF (Flash Override)

When you don't want the flash to fire, even in the dark.

In the Flash-OFF mode, the flash does not fire even in low-light conditions. Use this mode in situations where flash photography is not desired or is prohibited.

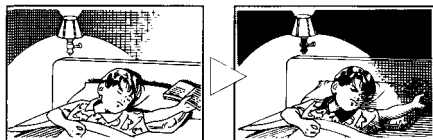

Note: Since a slow shutter speed (down to 2 seconds) is automatically selected in low-light situations, the use of a tripod is recommended to prevent blurred pictures caused by shaking the camera.

FILL-IN (Forced Activation)

When you want to fire the flash every shot.

In the FILL-IN Flash mode, the flash fires regardless of available light. This mode can be used to brighten up a subject's shaded face, for example.

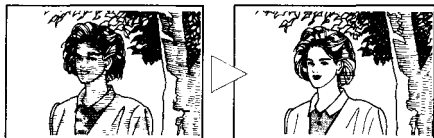

Night-Scene Flash

When you want both the subject in the foreground and the night-scene in the background to be properly exposed.

Use the Night-Scene Flash mode to properly light the subject in the foreground while leaving the background naturally lit.

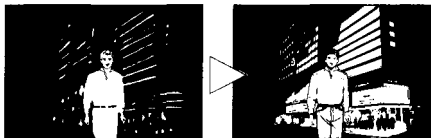

Note: Since a slow shutter speed (down to 2 seconds) is automatically selected in low-light situations, the use of a tripod is recommended to prevent blurred pictures caused by shaking the camera.

USING THE SUBJECT BUTTON

Press the SUBJECT button to select the required mode. Every time you press the SUBJECT button, the mode switches as shown below.

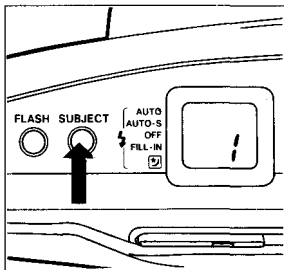

Mode	Function
	Self-Timer (p. 33) You can put yourself in the picture.
	Continuous Shooting (p. 34) You can shoot a continuous series of pictures.
	Dual-Frame Self-Timer (p. 35) You can take two self-timer pictures in rapid succession.
	Spot Metering (p. 36) You can limit light metering to a particular area of the framed picture.

Note: When the power is turned OFF and ON again, the camera returns to the Normal mode.

SELF-TIMER

To Put Yourself in the Picture

1. Press the SUBJECT button until  is displayed on the LCD panel.

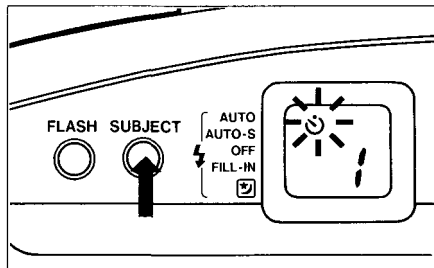

Notes:

- The focus and exposure will be locked when the shutter release button is depressed halfway.
- After the shutter is released, the camera will return to the Normal mode.
- To cancel the self-timer after it has been activated, press the SUBJECT button.

2. Aim at your subject, and press the shutter release button.

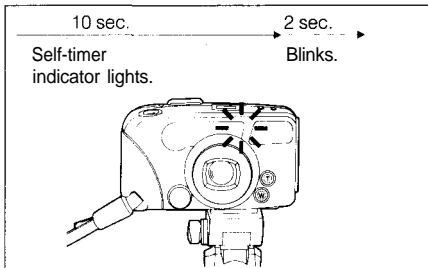

The shutter will be released 12 seconds later.

CONTINUOUS SHOOTING

To Shoot a Continuous Series of Pictures.

1. Press the SUBJECT button until **C** is displayed on the LCD panel.

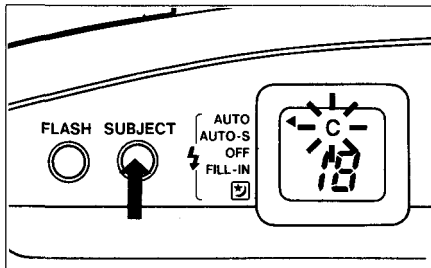

2. The camera will shoot repeatedly as long as the shutter release button is fully depressed.

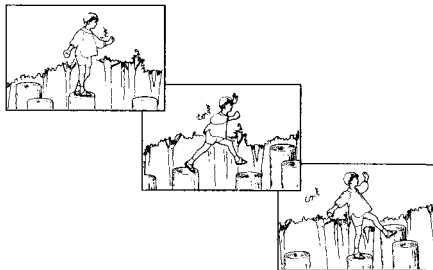

Notes:

- The shutter will release at intervals of 1.7 seconds (or 4 seconds after the flash fires).
- The focus and exposure will be adjusted every frame.
- If the subject gets closer than 0.65 m (2.1 ft), the shutter will automatically stop releasing.

DUAL-FRAME SELF-TIMER

To Take Two Self-Timer Pictures in Rapid Succession.

1. Press the SUBJECT button until  is displayed.

2. Aim at your subject, and press the shutter release button.

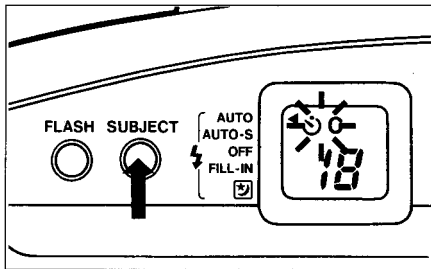

Notes:

- The interval between the first and second shutter release is approximately 2 seconds (or 5 seconds after the flash fires for the first shot).
- After the shutter is released for the second shot, the camera will return to the Normal mode.

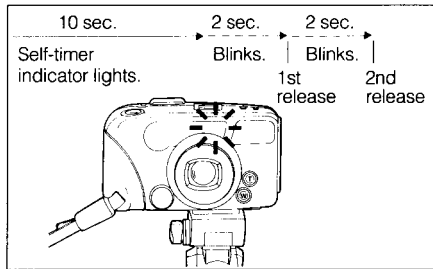

The shutter will be released for the first time in 12 seconds, and then for a second time 2 seconds later.

SPOT METERING

To Limit Light Metering to a Particular Area of the Framed Picture.

1. Press the SUBJECT button until  is displayed on the LCD panel.

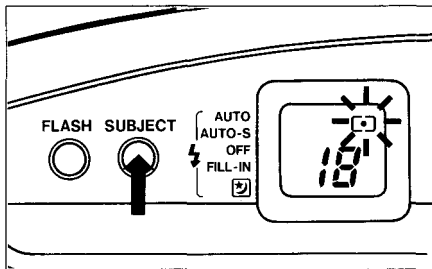

2. Position the autofocus frame over the desired area. Depress the shutter release button halfway to lock the exposure.

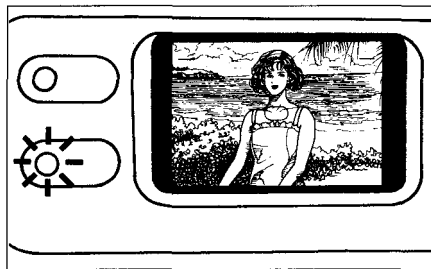

Note:
The focus will also lock when the shutter release button is depressed halfway.

3. Press the shutter release button fully to take pictures.

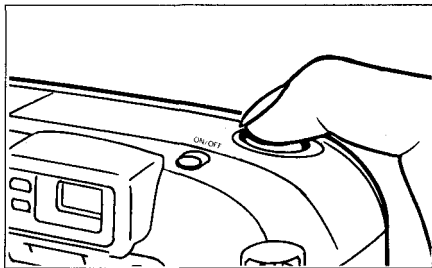

QUESTIONS AND ANSWERS

Q: How long will the batteries last?

A: If you use 24-exposure rolls of film and use the flash on half of all your pictures, two new 3V lithium batteries (DL123A/CR123A) will last for 30 or more rolls of film. If you do not use the flash and auto zoom very often, the batteries will last much longer.

Q: How should I clean the lens?

A: Wipe the lens gently with a soft, clean cotton cloth that has been moistened with a small amount of lens cleaning fluid.

Q: Can I use film that is not DX-coded?

A: Yes, but only ISO 100 film.

Q: When does the camera measure and set the exposure?

A: When the shutter release button is depressed halfway, the camera measures both the exposure and focus and locks them as long as the shutter release

button remains halfway depressed.

Q: I ran out of the stickers for the cartridge. Where can I get them?

A: Ask your nearest Olympus service center.

Q: Why doesn't the finished Panorama print show all the area that is shown on the Panorama picture negative?

A: In a Panorama print, the center portion of the film, about 12 mm x 36 mm, is printed, however, to ensure optimal print size, the actually exposed area on the negative is made a little larger. Also, the area exposed on the negative may be smaller or larger depending on the zoom setting. Please note, however, that the Panorama picture seen in the viewfinder will be the actual Panorama picture when printed.

(Refer to page 26 for close-up correction.)

CARE AND STORAGE

CAUTIONS

- DO NOT EXPOSE THE CAMERA TO EXTREME HEAT (OVER 40°C/104°F) OR TO EXTREME COLD (BELOW -10°C/14°F).
 - AVOID SUDDEN TEMPERATURE CHANGES AND HUMIDITY.
 - DO NOT EXPOSE THE CAMERA TO STRONG MAGNETIC FIELDS.
 - DO NOT APPLY EXCESSIVE FORCE TO THE CAMERA OR ITS CONTROLS.
 - DO NOT TOUCH THE CONTACT POINTS INSIDE THE CAMERA.
 - DO NOT USE ORGANIC SOLVENTS, THINNERS, OR BENZINE TO CLEAN THE CAMERA.
 - AVOID STRONG IMPACTS CAUSED BY BUMPING OR DROPPING THE CAMERA.
- DO NOT EXPOSE THE CAMERA TO WATER, SUCH AS FROM RAIN.
 - DO NOT EXPOSE THE CAMERA TO DUST AND SAND.

WARNING

- NEVER ATTEMPT TO DISASSEMBLE THE CAMERA; IT CONTAINS A HIGH-VOLTAGE CIRCUIT.

In case of malfunction, consult your nearest Olympus dealer or Olympus service center.

BATTERY HANDLING

NOTES

- Even when batteries are brand-new, their service life may be shorter than specified if an extended period of time has passed since they were produced.
- Do not mix different types of batteries or new and old batteries.
- Keep spare batteries on hand when going on a long trip or to a cold area.
- Sweat, oil, and so on can prevent a battery's terminals from making electrical contact. To avoid this, wipe both terminals before loading batteries.

WARNINGS

- NEVER TRY TO DISASSEMBLE, RECHARGE, OR SHORT CIRCUIT BATTERIES. NEVER EXPOSE BATTERIES TO EXCESSIVE HEAT OR OPEN FLAMES.
- KEEP THE BATTERIES OUT OF THE REACH OF CHILDREN. IF A CHILD SWALLOWS A BATTERY, CONTACT A DOCTOR IMMEDIATELY.
- USE TWO 3V LITHIUM BATTERIES (CR123A OR DL123A). NEVER TRY TO DISASSEMBLE OR MODIFY ANY BATTERY OR BATTERY PACK FOR USE IN THIS CAMERA.

TROUBLESHOOTING

OPERATING PROBLEMS

Symptom	Cause	Remedy	See
The camera does not work.	<ul style="list-style-type: none">① The power is OFF.② The alignment of the battery terminals is not correct.③ The batteries are exhausted.④ The batteries are temporarily unable to function.⑤ The loaded film has been rewind.⑥ The film is incorrectly loaded.	<ul style="list-style-type: none">① Press the power button again.② Reload the batteries correctly.③ Replace the batteries with new ones.④ Keep the camera warm while using it.⑤ Load new film.⑥ Reload the film.	<ul style="list-style-type: none">p. 18p. 12p. 13p. 40p. 24p. 17
The LCD display turns off suddenly.	<ul style="list-style-type: none">① The LCD display turns off after four and a half minutes if the camera is not used.	<ul style="list-style-type: none">① Press the power button twice or the shutter release button halfway to turn on the LCD panel. In addition, the power is turned OFF automatically after 4 hours. When the camera is not in use, keep the power OFF as much as possible.	
The green lamp blinks, and the shutter will not release.	<ul style="list-style-type: none">① The camera is closer than 0.65 m (2.1 ft) to the subject.	<ul style="list-style-type: none">① Move the camera farther than 0.65 m (2.1 ft) from the subject.	<ul style="list-style-type: none">p. 21
The orange lamp blinks, and the shutter will not release.	<ul style="list-style-type: none">① The flash has not been recharged yet.	<ul style="list-style-type: none">① Remove your finger from the shutter release button and wait for several seconds until the flash is recharged before shooting.	
The flash does not fire, even in the dark.	<ul style="list-style-type: none">① The flash mode is set to OFF.	<ul style="list-style-type: none">① Set it to a mode other than OFF.	<ul style="list-style-type: none">p. 28

PROBLEMS WITH THE PRINTED PICTURES

Symptom	Cause	Remedy	See:
The picture is out of focus.	<ul style="list-style-type: none"> ① The camera moved when the shutter release button was pressed. ② The subject was not within the viewfinder's autofocus frame. ③ The lens and autofocus windows were dirty. ④ The autofocus window was blocked, such as by a finger. ⑤ The subject was closer than the minimum working distance to the lens (0.65 m/2.1 ft). ⑥ While using the self-timer, the shutter release button was pressed while standing right in front of the camera. 	<ul style="list-style-type: none"> ① Hold the camera correctly and press the shutter release button gently. ② Position the subject in the center of the frame, or use the focus lock. ③ Clean the lens and autofocus windows. ④ Hold the camera correctly, keeping your fingers clear of the autofocus windows. ⑤ Shoot from more than 0.65 m (2.1 ft) away from the subject. ⑥ Do not stand in front of the camera. Press the shutter release button while looking through the viewfinder. 	<ul style="list-style-type: none"> p. 14 p. 22 p. 14 p. 21 p. 33
The picture is too dark.	<ul style="list-style-type: none"> ① The flash was blocked, such as by a finger. ② The subject was out of the working range of the flash. ③ The flash mode was set to OFF. ④ The subject was backlit. 	<ul style="list-style-type: none"> ① Hold the camera correctly, keeping your fingers clear of the flash. ② Shoot within the flash working range. ③ Check the flash mode before shooting. ④ Set the flash mode to FILL-IN. 	<ul style="list-style-type: none"> p. 14 p. 29 p. 28 p. 31

SPECIFICATIONS

Type: Full automatic 35mm autofocus lens-shutter camera with built-in 28–56mm zoom lens.

Film format: 35mm standard DX-coded film (24 X 36 mm, switchable to Panorama size).

Lens: Olympus lens 28–56mm F3.5–6.5, 8 elements in 7 groups.

Shutter: Programmed electronic shutter.

Viewfinder: Panorama-standard switchable Kepler type zoom viewfinder (with autofocus frame, close-up correction marks, autofocus indicator and flash indicator). Diopter correction possible.

Focusing: Active type autofocus system. Focus lock possible. Focusing range: 0.65 m (2.1 ft) - ∞ (infinity).

Exposure control: Programmed automatic exposure control. Center-weighted average light metering, switchable to spot metering. Auto exposure range: Wide-angle — EV2.8 (F3.5, 2 sec.) to EV15 (F8.4, 1/500 sec.), Telephoto — EV4.4 (F6.5, 2 sec.) to EV17 (F15, 1/500 sec.).

Exposure counter: Progressive type with automatic reset, displayed on LCD panel.

Self-timer: Electronic self-timer 12-sec. delay. Dual-frame self-timer possible.

Film speed range: Automatic setting with DX-coded film with ISO 50, 100, 200, 400, 800, 1600, 3200. For film with less than ISO 50, film speed is set to ISO 100.

Film loading: Automatic loading. (Automatically advances to first frame when camera back is closed).

Film advance: Automatic film winding.

Film rewind: Automatic film rewind (automatic rewind activation at end of film, automatic rewind stop). Rewind possible at any point with rewind button.

Flash: Built-in flash. Recycling time: Approx. 0.2 ~ 3.5 sec. (at normal temperature with new batteries). Flash working range: Wide-angle — 0.65 ~ 5.3 m (2.1 ~ 17.4 ft), Telephoto — 0.65 - 2.8 m (2.1 - 9.2 ft) with ISO 100 color negative film; Wide-angle — 0.65 - 10.6 m (2.1 ~ 34.8 ft), Telephoto — 0.65 ~ 5.6 m (2.1 ~ 18.4 ft) with ISO 400 color negative film.

Flash modes: AUTO (Automatic flash activation in low-light and backlight). AUTO-S (Red-eye reducing, in low-light and backlight). OFF (No flash). FILL-IN (Forced activation). 3 (For night scene with slowest shutter speed — 2 sec.).

Battery check: Displayed on LCD panel.

Power source: Two 3V lithium batteries (DL123A/CR123A).

Dimensions: 136(W) X 73(H) X 56(D) mm (5-3/8 X 2-7/8 X 2-3/16 in) (without protrusions).

Weight: 345 g (12.2 oz) (without batteries).

SPECIFICATIONS ARE SUBJECT TO CHANGE WITHOUT ANY OBLIGATION ON THE PART OF THE MANUFACTURER.

OLYMPUS®

OLYMPUS OPTICAL CO., LTD.

San-Ei Building, 22-2, Nishi Shinjuku 1-chome, Shinjuku-ku, Tokyo, Japan. Tel. 03- 3340-2211

OLYMPUS CORPORATION

Crossways Park, Woodbury, New York 11797-2087, U.S.A. Tel. 516-364-3000

OLYMPUS OPTICAL CO.(EUROPA)GMBH

Postfach 104908, Wendenstrasse 14-16, 2000 Hamburg 1, Germany. Tel. 040-23773-0

OLYMPUS OPTICAL CO. (U.K.) LTD.

2-8 Honduras Street, London EC1Y 0TX, United Kingdom. Tel. 071 2532772